

Oxylog 3000

Emergency and transport ventilator

Instructions for Use
Software 1.n



This "Instructions for Use" manual is published for public use and is only meant for your information.
We do not guarantee the accuracy of these instructions with respect to your specific device type or status.
Only the "Instructions for Use" manual delivered together with a device is officially published for the use of that specific device.

How to use these Instructions for Use

The header line ...
specifies the subject of the main chapter.

It is followed by the title of the sub-chapter – to help you find your way rapidly around the manual.

The page body ...
contains the instructions for use

in a combination of text and illustrations. The information is expressed directly in terms of actions which enable users to familiarise themselves with the operation of the machine by hands-on activity.

The left-hand column ...
contains the text

which provides explanations and guides the user with brief and clear instructions in an ergonomic sequence for confusion free use of the machine.

Bullet points indicate the working steps, numbers are used to highlight the relation between the working step described, the associated illustration(s) and the sequence of operations.

The right-hand column ...
contains the illustration(s)

which directly relate to the text opposite and show the user where to find the items concerned. The focus is on the elements mentioned in the text. Non-essentials are omitted. Screen dumps are also used to guide the user and confirm the working steps.

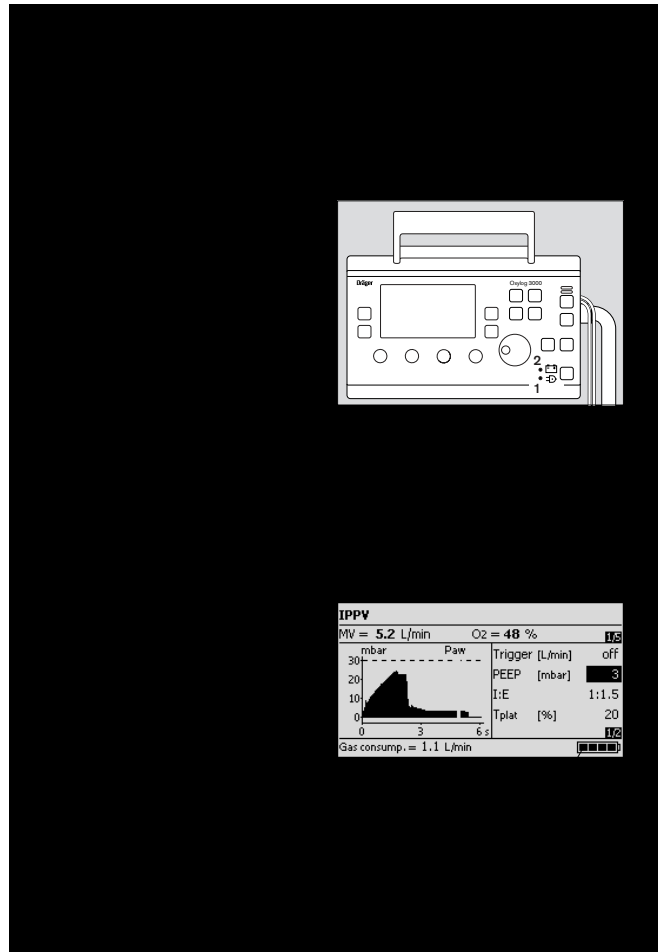

Contents

[Redacted]
[Redacted]
[Redacted]
[Redacted]
[Redacted]
[Redacted]
[Redacted]
[Redacted]
[Redacted]
[Redacted]
[Redacted]
[Redacted]
[Redacted]
[Redacted]
[Redacted]
[Redacted]
[Redacted]
[Redacted]



For Your Safety and that of Your Patients	6
Precautions	6

For Your Safety and that of Your Patients

Strictly follow the Instructions for Use

Any use of the apparatus requires full understanding and strict observation of these instructions.

The apparatus is only to be used for purposes specified here.

Maintenance

The apparatus must be inspected and serviced by trained service personnel every two years.

Repair and general overhaul of the apparatus may only be carried out by trained service personnel.

We recommend that a service contract be obtained with DrägerService and that all repairs also be carried out by them.

Only authentic Dräger spare parts may be used for maintenance.

Observe chapter "Maintenance Intervals".

Accessories

Do not use accessory parts other than those in the order list.

Liability for proper function or damage

The liability for the proper function of the apparatus is irrevocably transferred to the owner or operator to the extent that the apparatus is serviced or repaired by personnel not employed or authorized by DrägerService or if the apparatus is used in a manner not conforming to its intended use.

Dräger cannot be held responsible for damage caused by non-compliance with the recommendations given above. The warranty and liability provisions of the terms of sale and delivery of Dräger are likewise not modified by the recommendations given above.

Dräger Medical AG & Co. KGaA

Precautions

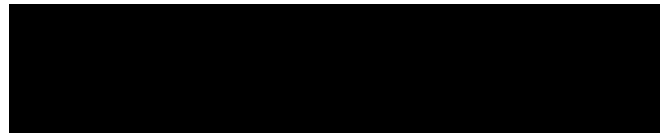
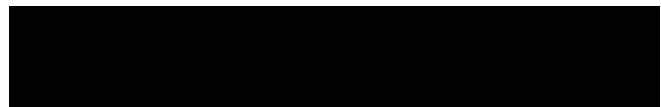
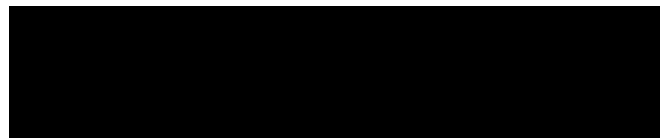
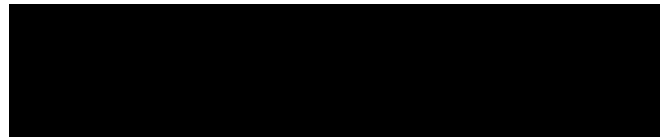
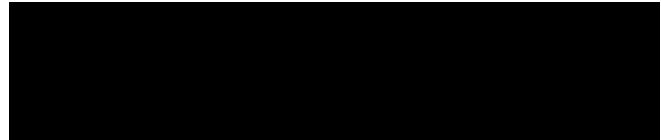

Manual ventilation equipment must be kept ready to hand

If the life-supporting function of the ventilator can no longer be guaranteed on account of a fault, such as a power failure or break in the medical gas supply, ventilation of the patient must be continued without delay using other ventilation equipment, such as a manual ventilation bag Resutator 2000, with PEEP and/or increased inspiratory O₂ concentration if necessary. See Order List on page 102.

Not for use in areas of explosion hazard

This apparatus is neither approved nor certified for use in areas where combustible or explosive gas mixtures are likely to occur.

* Dräger medical equipment fulfils the interference resistance requirements according to the product-specific standards or EN 60601-1-2 (IEC 601-1-2). However, depending on the design of the mobile phone and circumstances of use, field strengths may occur in the immediate environment of a mobile phone that exceed the limits of the above standards and therefore cause interference.



Intended Medical Use 8

Intended Medical Use

Oxylog[®] 3000 is a time-cycled, volume-constant and pressure-controlled emergency and transport ventilator for patients with a tidal volume from 50 mL upwards.

With the following ventilation modes

- IPPV/IPPVAssist (CMV/CMVAssist*)
Intermittent Positive Pressure Ventilation
Controlled and assisted volume-constant ventilation with PEEP for CPPV.
- SIMV/ASB (SIMV/PS)
Synchronized Intermittent Mandatory Ventilation
Procedure for weaning patients off the ventilator after they have started spontaneous breathing, with adjustable pressure assist during spontaneous breathing.
- CPAP/ASB (SIMV/PS)
Continuous Positive Airway Pressure
Spontaneous breathing with positive airway pressure and adjustable pressure assist.
- BIPAP/ASB** (PCV+/PS*)
Biphasic Positive Airway Pressure
Pressure-controlled ventilation combined with free spontaneous breathing during the complete breathing cycle, and adjustable pressure assist on CPAP level.

The settings PCV+, PS and CMV can be viewed in the US-English display, see "Customer Service Mode", "Display language text", page 81.

Special modes

- Apnoea Ventilation
For switching over automatically to volume-controlled mandatory ventilation, if breathing stops.
- NIV
Non-invasive ventilation for mask ventilation with leakage compensation.

For O₂ inhalation

- with inhalation mask

With monitoring

- Airway pressure Paw
- Expiratory minute volume MV
- Apnoea
- Rapid shallow breathing: High frequency alarm

* CMV Controlled Mandatory Ventilation
PCV+ Pressure Controlled Ventilation plus
PS Pressure Support

** Licensed trademark

Areas of use

Mobile use for emergency medical care or primary care of emergency patients:

- During transport in emergency rescue vehicles or by helicopter,
- In accident and emergency departments, in the recovery room.

Mobile use for secondary transfers:

- During transfer by road or air
- When moving ventilated patients around the hospital.

These Instructions for Use describe the maximum equipment configuration for Oxylog 3000.

Depending on the actual configuration used, the maximum equipment may not include the following options:

- O₂ blending
- BIPAP (PCV+)
- ASB (PS)
- O₂ inhalation
- 100 % O₂



Operating concept	10
Key for switching on/off	10
Ventilation Controls	10
Selecting the ventilation mode	11
Keys for routine and additional functions	11
Screen Operating Controls	11
Structure of the screen windows	12
"Values" screen window	12
"Settings" screen window	12
"Alarms" screen window	13
Pressure curves main page	13
Flow curves main page	13
Information window on screen	14

Operating concept

Key for switching on/off

- 1 To switch on, briefly press the »⏻« key.
- 1 To switch off, hold down the »⏻« key for about 3 seconds and
- 2 confirm the switch-off prompt = press rotary knob.

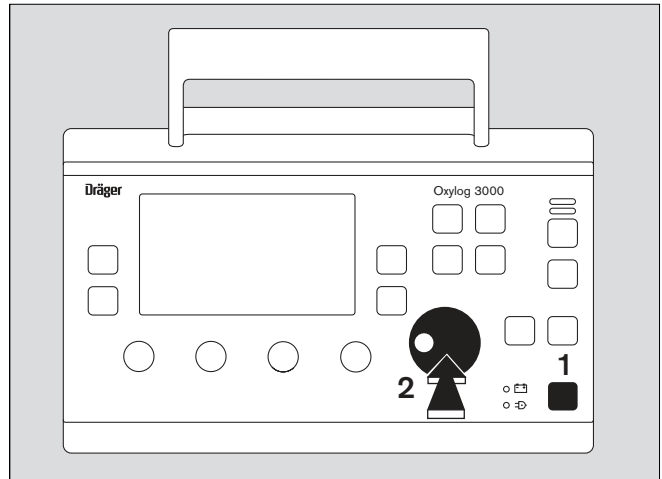

Ventilation Controls

- 3 Keys for selecting the ventilation modes:
 - IPPV (CMV), SIMV, CPAP
 - BIPAP (PCV+)*
 - SIMV/ASB (SIMV/PS)*
 - CPAP/ASB (CPAP/PS)*
 - BIPAP/ASB (PCV+/PS)*

The operating concept takes into account the various purposes for which the ventilator is used.

For primary care

When configured accordingly, Oxylog 3000 starts in IPPV ventilation mode with user-configured starting values for I:E (1:1.5 as default setting) and PEEP (5 mbar as default setting).

The most important ventilation parameters are set with the aid of the controls below the screen:

- 4 – Tidal volume V_T [mL],
- Ventilation frequency **Freq.** [1/min],
- Max. inspiratory pressure **P_{max}** [mbar],
- O₂ concentration **O₂** [%]

During secondary transfers

different ventilation modes and their parameters can be set in the screen window via the central rotary knob when selected accordingly (e.g. T_{insp}, PEEP, Δ ASB, P_{insp})

- 5 To select parameter = turn rotary knob
- To activate parameter = press rotary knob
- To set value = turn rotary knob
- To confirm value = press rotary knob

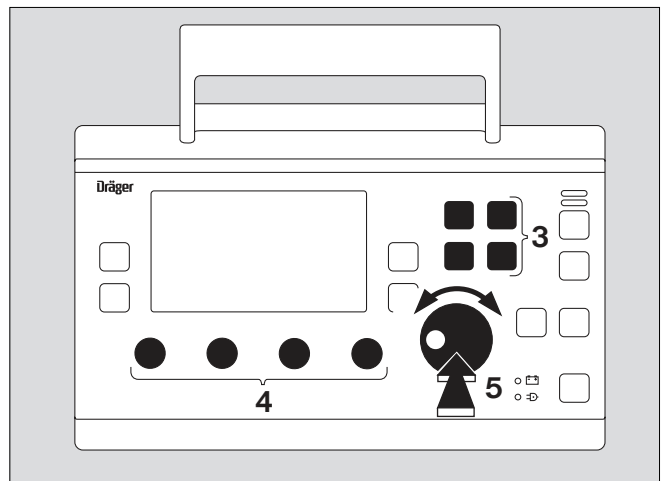

* SIMV/ASB, CPAP/ASB and BIPAP/ASB are optional ventilation modes.

Selecting the ventilation mode

- 1 Hold down the appropriate key for the ventilation mode for about 3 seconds
or
- 1 press the appropriate key briefly and
- 2 confirm. The selected ventilation mode will now be activated.
- 3 The actual ventilation mode is displayed in the top left-hand corner of the screen.
For detailed instructions on setting the ventilation modes, see pages 32 onwards.

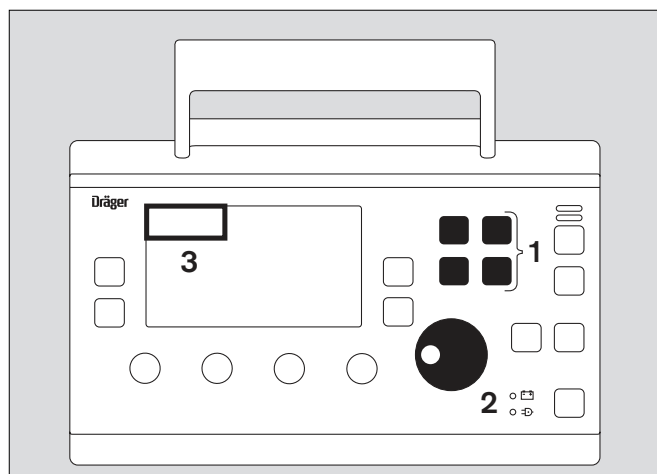

Keys for routine and additional functions

Frequently used keys for routine functions are positioned on the right-hand side of the front panel:



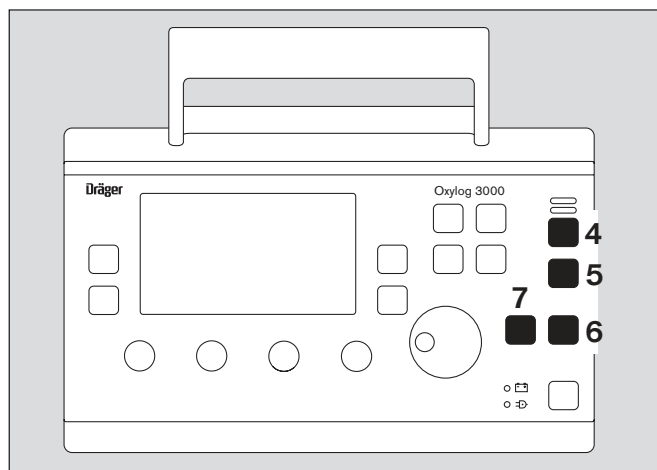

- 4 »  « key for suppressing the audible alarm tone for 2 minutes.
- 5 »Alarm Reset« key for acknowledging or resetting messages.
- 6 »Insp. hold« key for manually activated inspiration and for extending the inspiration time.
- 7 »O₂-Inhalat.« key (optional) for O₂ inhalation or
»100% O₂« key (optional) for 100 % O₂ application.



Screen Operating Controls

- 8 Central "turn and push" rotary knob for selecting and setting the options displayed on the screen.

Screen operating keys:

- 9 »Values  « key for changing screen pages in the "Measured values" window in order to display the measured values.
- 10 »Curves  « key for selecting the main page to display the pressure curve or flow curve.
- 11 »Set.  « key for superimposing or changing screen pages in the "Setting" window in order to set other ventilation parameters.
- 12 »Alarm  « key for superimposing or changing screen pages in the "Alarms" window in order to set and display the alarm limits.

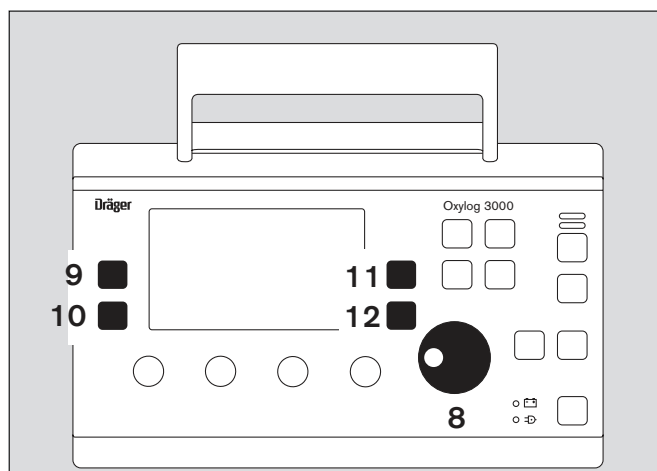

Changing screen pages in the windows

To change to the next page in the "Setting" or "Alarms" window:

- 11 press »Set.  « key

or

- 12 »Alarm  « key again.

To change to the pressure or flow curves main page:

- 10 Press »Curves  « key.

Structure of the screen windows

- 1 Status and alarm messages window
- 2 Measured values display window
- 3 Curves and measured values window
- 4 Settings and alarms window
- 5 Information window

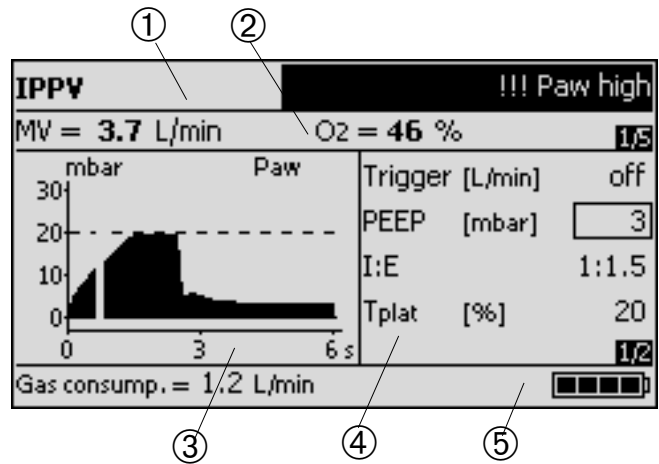

05437171

"Values" screen window

- 6 Line displaying all the measured values in the current ventilation mode.
 - 7 Successful triggering by the patient is indicated by the brief appearance of an asterisk in the upper line, between indication of the ventilation mode and the alarms window.
 - 8 Measured values **1/5** :
1st page of 5 available pages
- To change to the next page:
- Press »Values ▷▷◀ key.
The pages are displayed consecutively.

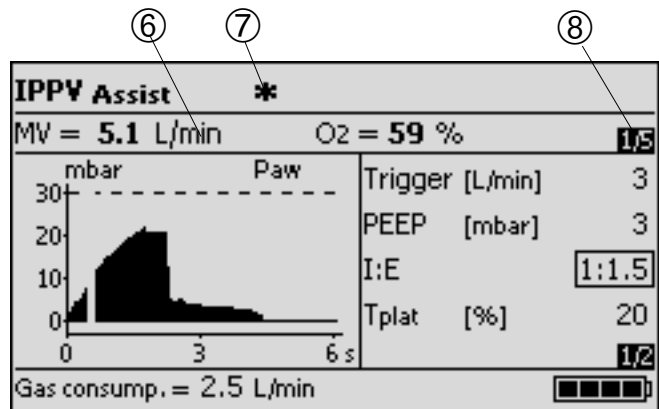

06837171

"Settings" screen window

- 9 Setting menu for setting the supplementary ventilation parameters in accordance with the desired ventilation mode:
 - Ventilation time ratio »I:E«,
 - Inspiration time »T_{insp}«,
 - Positive end expiratory pressure »PEEP«,
 - Pressure support »Δ ASB«,
 - Inspiratory pressure »P_{insp}«,
 - Sensitivity »Trigger«,
 - Plateau time »T_{plat}«,
 - Pressure rise time »Ramp«,
 - Non-invasive ventilation »NIV«,
 - Screen brightness,
 - Frequency for apnoea ventilation f_{Apnoea},
 - Tidal volume for apnoea ventilation VT_{Apnoea}
- 10 Setting **1/2** :
1st page of 2 available pages.
- Select Parameter.
The selected parameter is indicated by a frame.

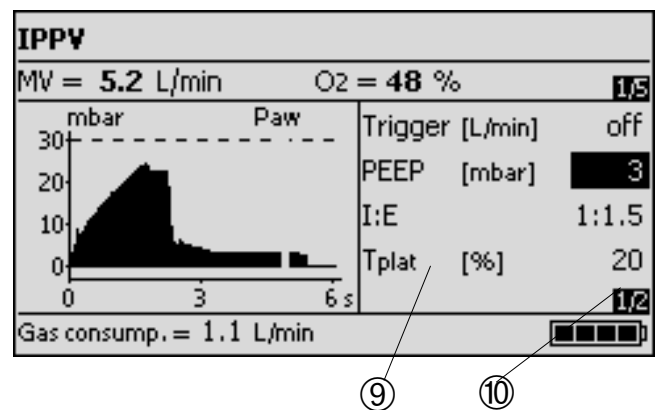

05237171

- Activate parameter for setting.
The active parameter appears light on a dark background.

- Set parameter and confirm.

To change to the next page:

- Press »Set. ▷▷ « key.
The pages are displayed consecutively.

"Alarms" screen window

1 Setting menu for setting alarm limits and alarm parameters.

For detailed operating instructions, see "Setting alarm limits" on page 44.

Alarms 1/2 :

First of two pages in the menu.

To change to the next page:

- Press »Alarm ▷▷ « key.
The pages are displayed consecutively.

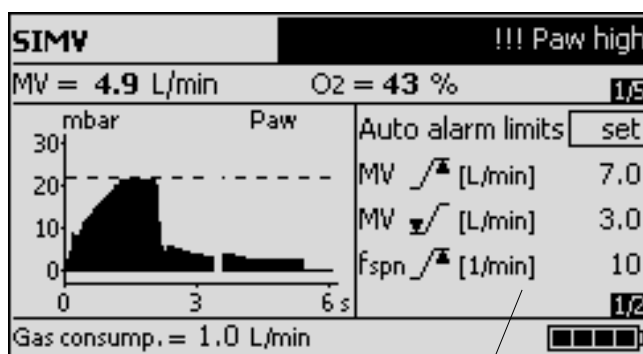

10087171

Pressure curves main page

Displays the Paw (t) curves.

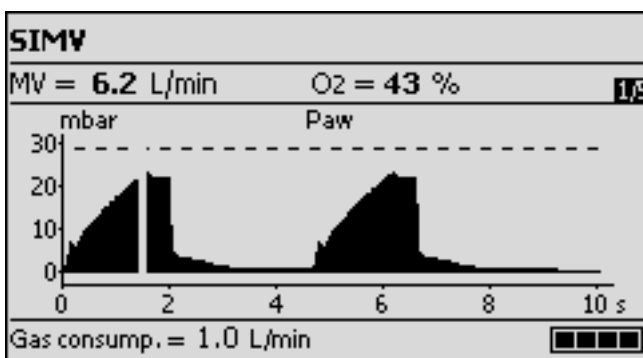

05687171

Flow curves main page

Displays the Flow (t) curves.

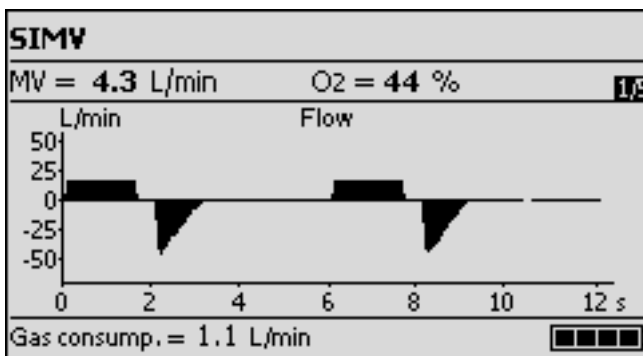

05687171



To change to the next page:

- 1 Press »Curves  « key.

The pages are displayed consecutively.

To select other screen pages:

- Press the appropriate keys, e.g.

- 2 screen page »Set.   «

or

- 3 »Alarms   «.

To return to the pressure curves or flow curves main page:

- 1 Press »Curves  « key.

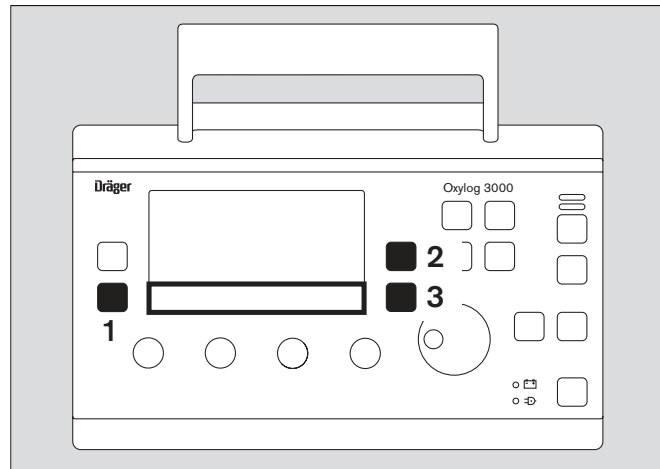

Information window on screen

When f and V_T are set with the aid of the controls below the screen, Oxylog 3000 simultaneously displays the numerical values for these parameters in the information window.

During setting of a ventilation parameter, Oxylog 3000 calculates the derived parameters and displays them in the information window.

If I:E is changed, for example, Oxylog 3000 will simultaneously display the resultant change in the derived parameters "Flow" and "T_{insp}".

If the PEEP value is set to more than 10 mbar, Oxylog 3000 will display a screen prompt which must be confirmed by the operator:

Confirm PEEP above 10 mbar ?

- Press rotary knob to confirm.

Higher PEEP values can then be set.

All displays generated in the information window by settings disappear when the setting is complete. Information on the battery charge and gas consumption is displayed as default.

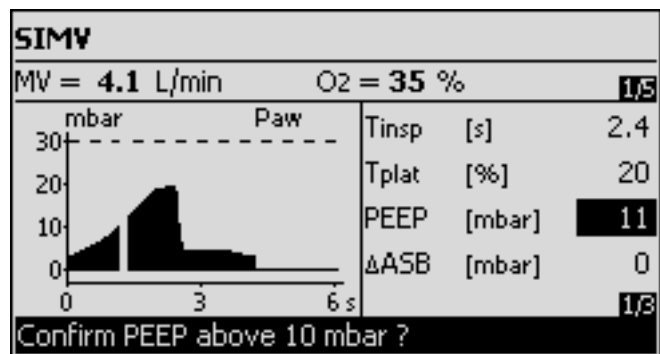
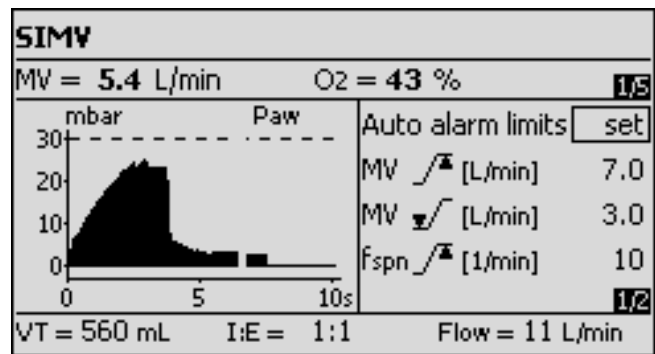



Preparation	16
Assemble reusable hose set	16
Connect disposable hose set	18
Connecting power supply	19
Internal supply with rechargeable battery	19
External power supply with DC/DC converter	21
External power supply from power supply unit	21
Connecting gas supply	22
Before using for the first time	24

Preparation

Reusable or disposable ventilation hose sets can be used.
See Order List on page 102.

The Carrier System 3000 (optional) – see page 72 – is available for transport under operating conditions.

The onboard equipment holder 3000 (optional) – see page 74 – is available for positioning the Oxylog 3000 in the vehicle.

Assemble reusable hose set

- Parts must always be sterilised before use!

Breathing valve, assembly

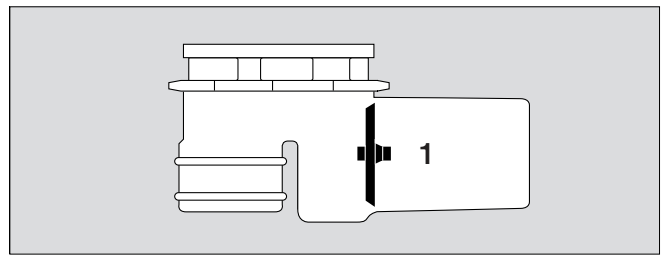
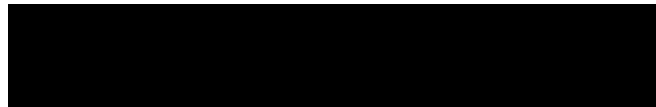

01837170

- 2 Place diaphragm in breathing valve – ensure that it is inserted correctly.
- 3 Fit cover and turn approx. 90° clockwise = lock.
- 4 Push flow sensor into breathing valve; note preferred position as indicated by groove.
- 5 Push angled connector onto flow valve.

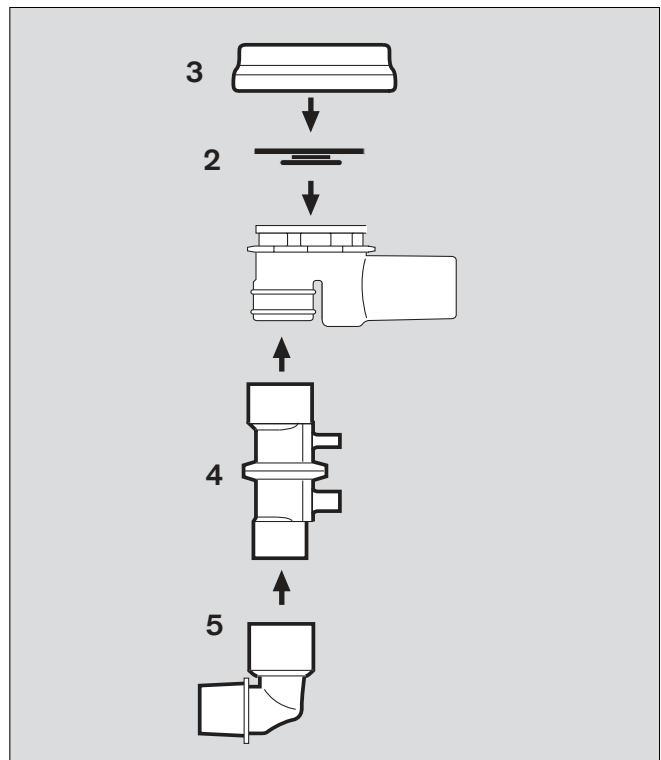
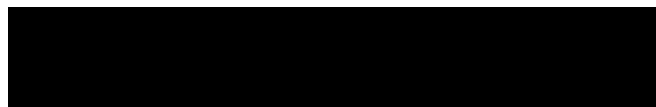

01837170

When using a bacterial filter or HME (Heat Moisture Exchanger)

- Connect the bacterial filter or HME to the angled connector.



The flow measurement function on the patient side does not depend on the use of an HME.

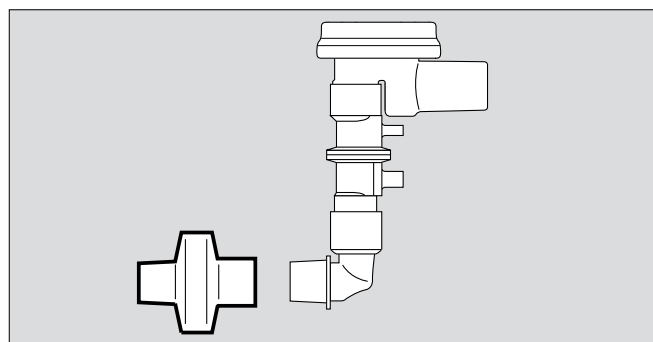

02037170

- 1 Connect ventilation hose to socket of breathing valve.



- 2 Connect flow measuring hoses to sockets on flow sensor – note different diameters.

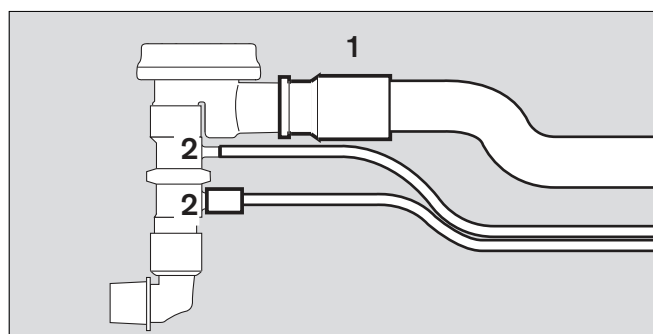

02037170

- 3 Plug flow measuring hoses into Oxylog 3000.



- 4 Connect ventilation hose to socket on Oxylog 3000.

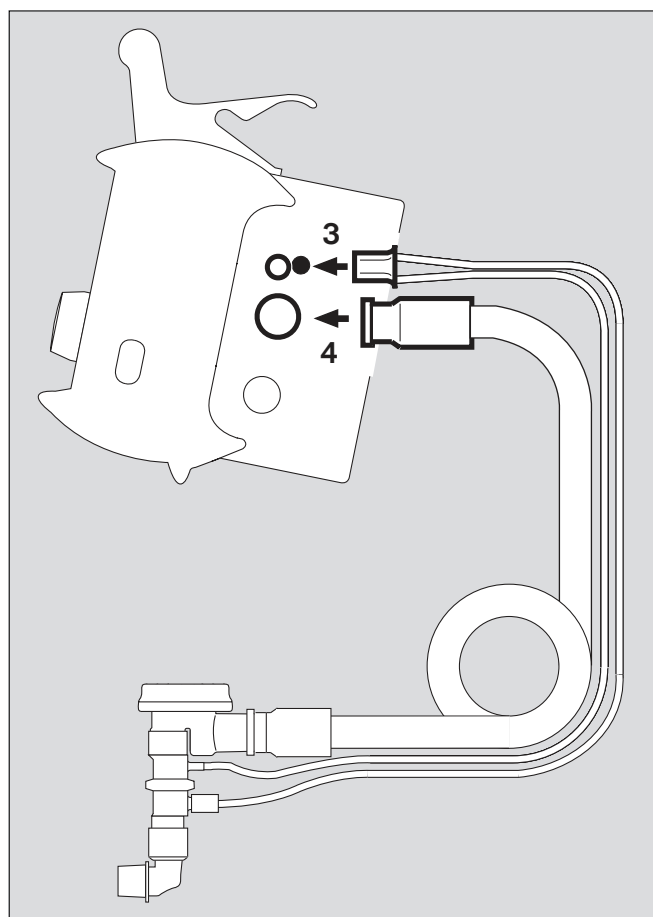

02037170

Connect disposable hose set

- instead of the reusable hose set.

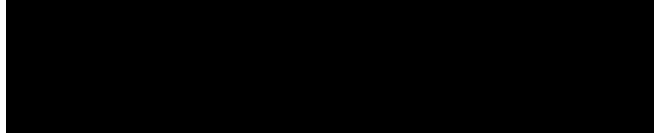

The service temperature range of the device is limited to -10 °C to 50 °C when using the disposable hose set.

- 1 Connect blue flow measuring hose to the blue socket,
- 2 and the transparent flow measuring hose to the other socket.



- 3 Connect ventilation hose to socket on Oxylog 3000.

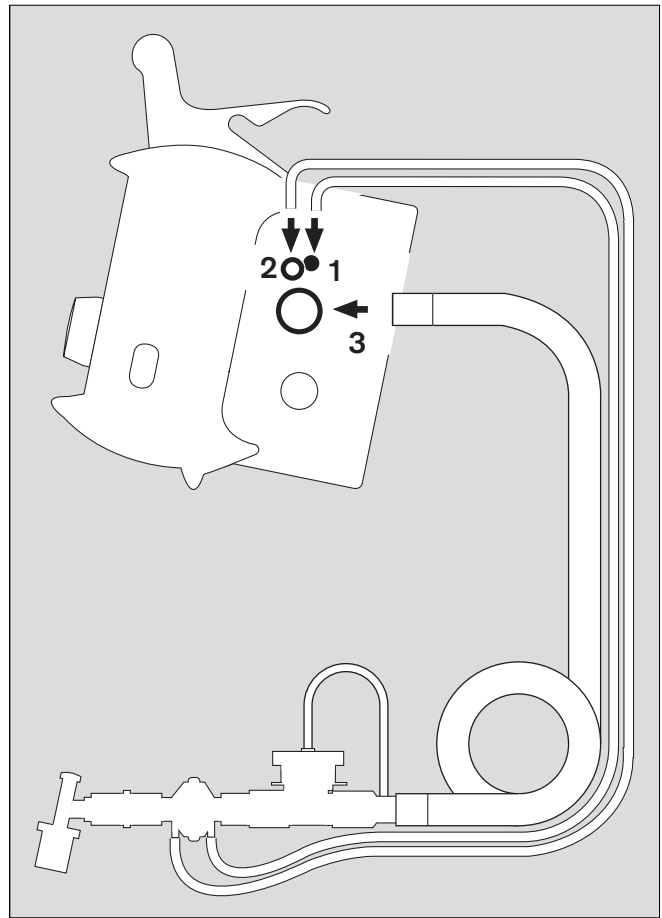

02187-170

When using a bacterial filter or HME (Heat Moisture Exchanger)

- Connect bacterial filter or HME.



The flow measurement function on the patient side does not depend on the use of an HME.

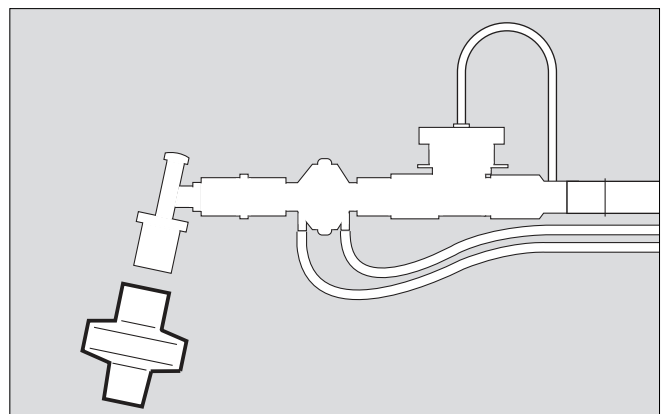

02187-170

When changing the ventilation hose set

If the reusable ventilation hose set is to be used instead of the disposable hose set or vice versa:

- Have sockets on device changed by specialists and
- reconfigure device accordingly, see "Customer Service Mode", page 76.

Connecting power supply

Oxylog 3000 is designed to operate on power supplies with different voltages:

Internal supply

- with rechargeable battery (specified Smart Battery, see "Technical Data", page 88)

Additional external power supply

To recharge the battery and to extend the electrical operation time when using a rechargeable battery.

- DC voltage from the on-board power supply via DC/DC converter
or
- with AC/DC power pack.



- Have a fully charged battery on hand, page 20.

The device can only ventilate the patient continuously even when the external power supply is interrupted if fully charged batteries are always available.

Internal supply with rechargeable battery

Replacing the battery

See "Technical Data", page 90, for a list of suitable types.

On the connection side:

- 1 Turn screw on battery compartment cover anticlockwise until the cover can be opened.
- 2 Swing the cover downwards,
- 3 pull the battery forwards by the tab and remove it.

Check the charge of the charged battery:

- Press button on rechargeable battery: its charge is indicated as a percentage by LEDs.

Recommendation:

- Use fully charged batteries.

- 3 Push the fully charged battery in – plug connector at bottom –
- 2 swing cover upwards,
- 1 and tighten screw.

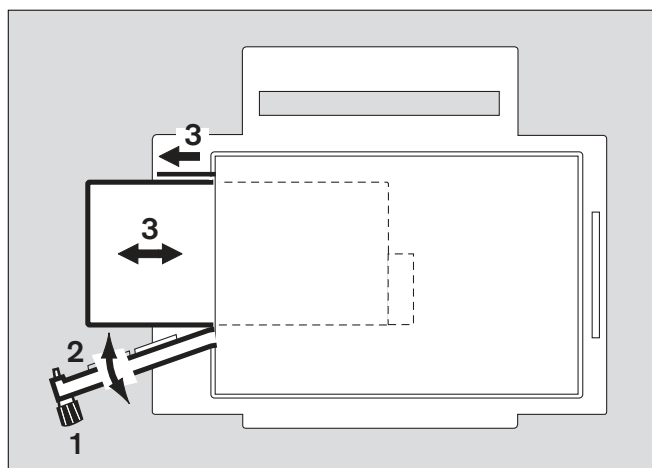

Oxylog 3000 will interrupt ventilation when the battery is replaced while the device is switched on and the external power supply is not connected. It resumes ventilation with the last values set not more than 3 seconds after fitting a fully charged battery.





Charging the battery

- The ambient temperature must be between 0 and 35 °C when charging the batteries!

When the external supply is available:

- 1 the green lamp »  «, lights up regardless of whether the ventilator is switched on or off. The battery is being charged.
- 2 The three-coloured indicator »  « lights up to show the momentary charge status of the battery:
 - yellow: while the battery is still being charged,
 - green: when the battery has been fully charged,
 - red: if a serviceable battery has not been inserted or cannot be charged, for instance because the ventilator is being used outside the temperature range from 0 to 35 °C.

Indicators »  « and »  « remain off while the ventilator is being operated from the internal battery.

An Oxylog 3000 charging station connected to the mains supply can be used to charge the battery externally, see "Order List", page 102.

- Refer to the manufacturer's technical specifications for further information on the charging and discharging characteristics (e.g. memory effect) of the battery used.

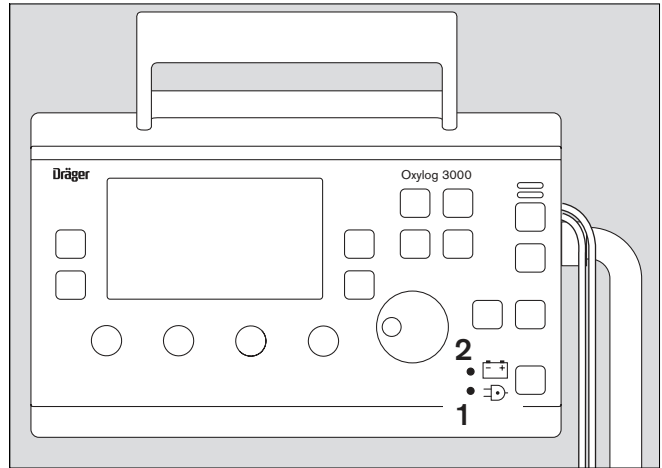

Indication of battery capacity / battery operation

- 3 The current capacity of the battery is indicated by Oxylog 3000 in 25% increments in the bottom right-hand line of the information window when switched on:

- when charging from an external power supply,
- as the battery is discharged during operation.

Example: 75 % charge

The accuracy of the capacity indication can vary, depending on the age and degree of use of the battery, see "Technical Data", page 90.

The capacity indication is overwritten if other, more important messages have to be displayed on the ventilator.

Additional alarms draw attention to the remaining operating time of the battery.

When operated via the rechargeable battery, the brightness of the ventilator screen is reduced in order to save power.

The screen brightness is automatically increased to maximum for one minute while settings are being made.

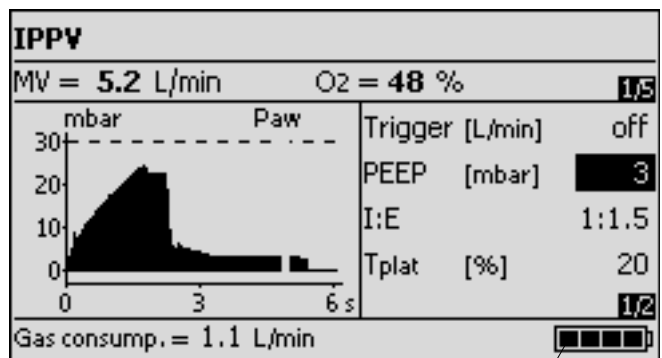

External power supply with DC/DC converter

The DC/DC converter should be used to connect the Oxylog 3000 to on-board supplies of different voltages (12 V, 24 V, 28 V DC). The voltage of the on-board supply may fluctuate, depending on the amount of power required for various purposes with the result that the supply voltage falls below or exceeds the range permitted for the Oxylog 3000. The on-board voltage is converted into a constant DC voltage of approx. 19 V DC by the DC/DC converter:

- When connected to an external power supply (e.g. the on-board power supply of the vehicle), the ventilator must always be connected via the DC/DC converter, see "Order List", page 102.
- 1 Plug the large connector of the DC/DC converter into the on-board supply
 - 2 and the small connector into the DC socket of the Oxylog 3000.
 - 3 When the Oxylog 3000 is connected to an external supply, the indicator »  « lights up and shows that the battery can be recharged.

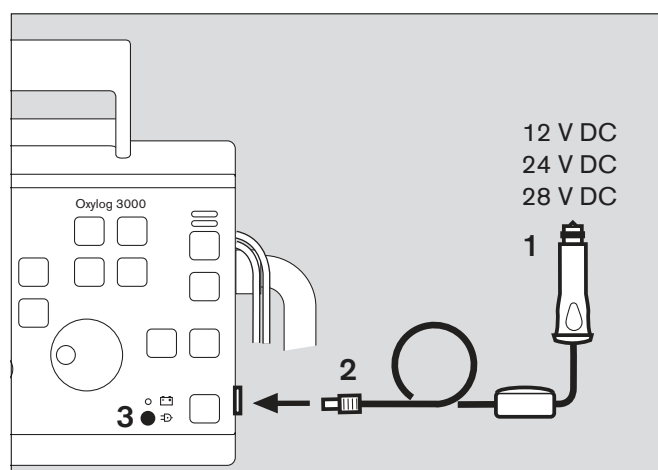

External power supply from power supply unit

- Only a specified AC/DC power supply unit may be used. See Order List on page 102.
- 4 Connect mains plug to mains socket
 - 5 and DC plug to DC socket on Oxylog 3000.
 - 6 When the Oxylog 3000 is connected to an external supply, the indicator »  « lights up and shows that the battery can be recharged.

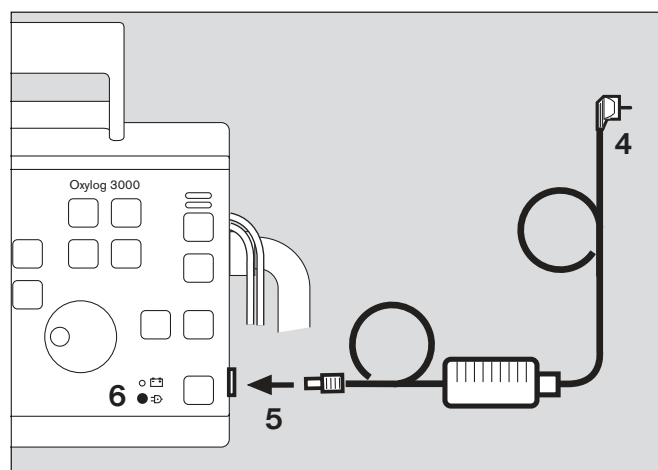

Connecting gas supply

Take care when handling O₂:

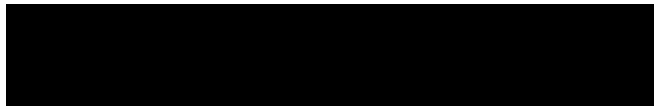

- Only open or close cylinder valves by hand and rotate smoothly. Do not use tools.



Oxylog 3000 can be supplied with either O₂ or medical air.

- The gas type must be set in the configuration menu to ensure correct metering, "Selecting the gas type", page 52.

Supply from an O₂ cylinder

- Only use compressed gas cylinders which comply with national regulations and have been approved.
 - Use a full O₂ cylinder (200 bar).
 - Screw pressure reducer (2.7 to 6.0 bar delivery pressure, 5 bar nominal pressure) to O₂ cylinder.
 - Only use a pressure reducer with a vent valve at the outlet to limit the delivery pressure to a maximum of 10 bar in case of a fault!
- 1 Screw O₂ medical gas hose into Oxylog 3000.
 - 2 Connect O₂ medical gas hose to pressure reducer.
 - 3 Turn cylinder valve slowly and open fully.

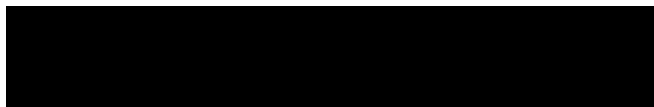

The Carrier System 3000 (optional) – see page 72 – is available for transporting the Oxylog 3000 under operating conditions.

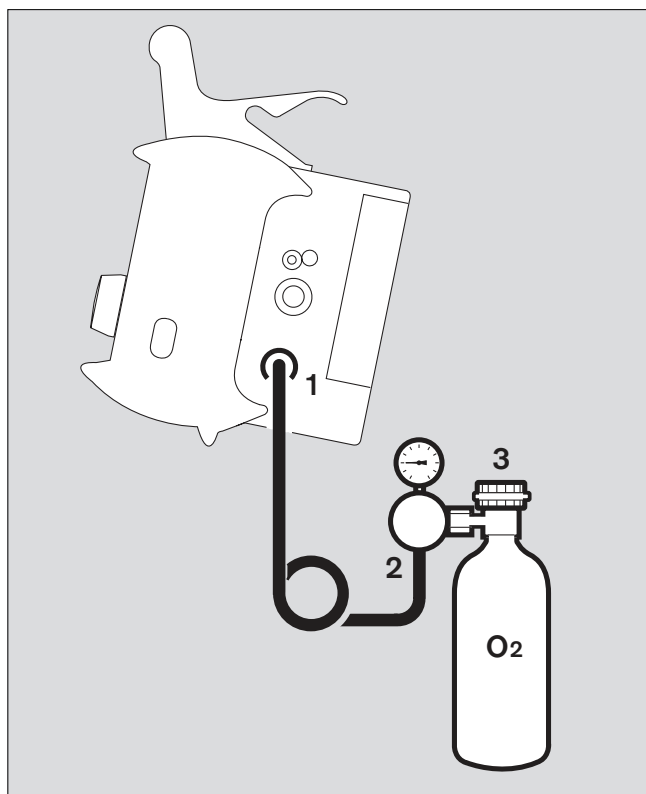

02659170

Determining the approximate pneumatic operating time for Oxylog 3000

Example for supply of medical gas:

Cylinder pressure measured on the pressure gauge of the pressure reducer: 200 bar

Liquid capacity of the O₂ cylinder: 2.5 L

Supply of medical gas: 2.5 L x 200 bar = approx. 500 L

Example for pneumatic operation time:

IPPV mode, frequency 10 1/min, V_T = 1 L, O₂ = 100 %

Minute volume = 10 1/min x 1 L = 10 L/min

$$\text{Operation time} = \frac{\text{Medical gas supply [L]}}{(\text{MV} + 0.5^*) \text{ [L/min]}}$$

$$\text{Operation time} = \frac{500}{10.5} = \text{approx. 48 minutes}$$

The pneumatic operation time increases when Oxylog 3000 operates with an O₂ concentration of less than 100 % O₂, since it additionally draws in ambient air in this case.

- 1 The amount of gas from the high-pressure supply which has currently been consumed is indicated by Oxylog 3000 in the bottom left-hand line of the information window in L/min (gas consumption of ventilator + MV of the patient). This display is overwritten if other, more important messages have to be displayed on the ventilator.

Example:

O₂ consumption = 2.5 L/min

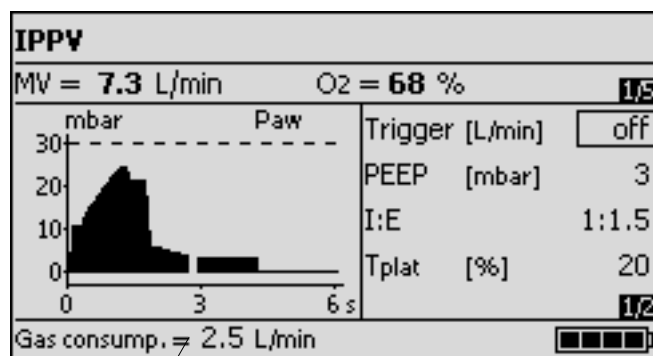

* Gas consumption of ventilator: max. 0.5 L/min

Supply from a piped medical gas system

- 1 Screw O₂ medical gas hose into Oxylog 3000 and
- 2 plug gas probe into O₂ terminal unit until it has engaged twice and the supply of O₂ is assured.

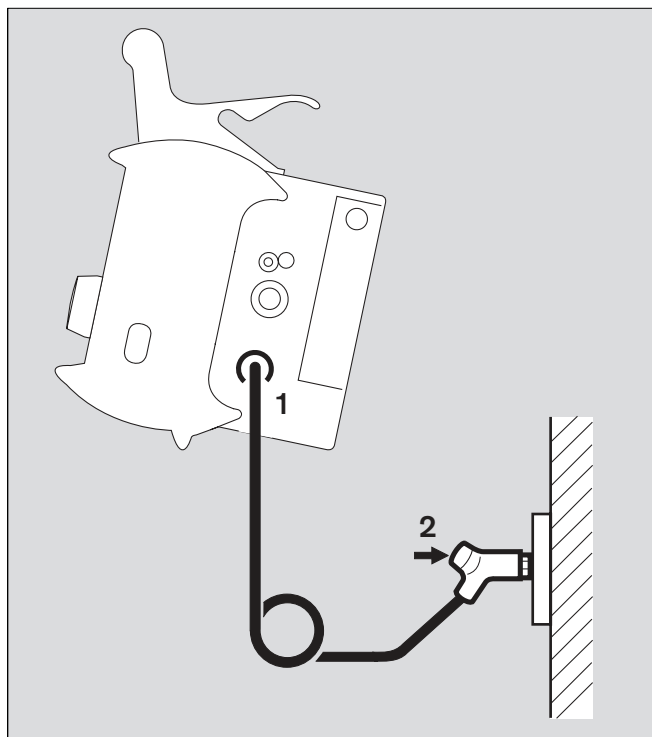

Before using for the first time

- Ensure that batteries are fully charged, page 20.



Checking readiness for operation	26
Connecting test lung	26
Perform device check	26
Error messages during device check	30

Checking readiness for operation

- whenever the ventilator has been prepared or the ventilation hoses changed
- at the latest every six months.

The following functions are checked with the menu-based test:

- Gas supply present
- Hose system / breathing valve connected and OK
- Alarm functions OK
- Ventilation functions OK
- Monitor functions OK.

Oxylog 3000 interrupt the test if a fault is detected.
The relative fault is indicated on the screen.



Connecting test lung

The test lung comprises:

- 1 an angled connector for connection to the ventilation valve,
- 2 a catheter connector, diameter 7 mm, in the angled connector – to simulate the resistance of the airways.
- 3 2 L breathing bag 84 03 201 to simulate the lung compliance.

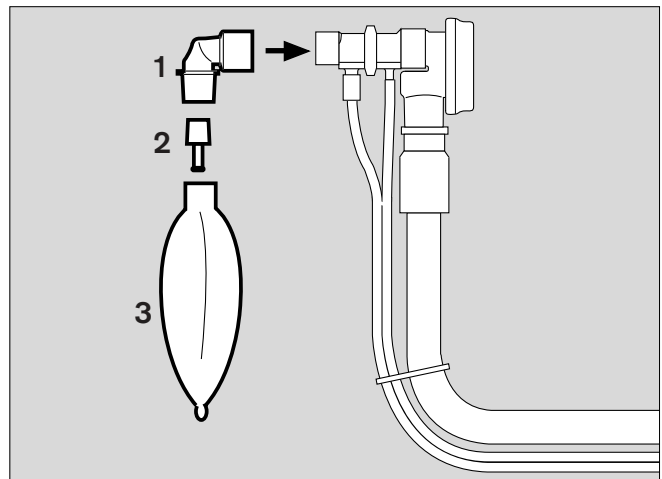

Perform device check

Duration: approx. 3 minutes.

- 4 Switch Oxylog 3000 on = press the »⏻« key. The device runs through a self-test and the operator is prompted, on the display, to call up the configuration menu or device check:
Press rotary knob for device check and configuration
- 5 Press rotary knob to confirm.

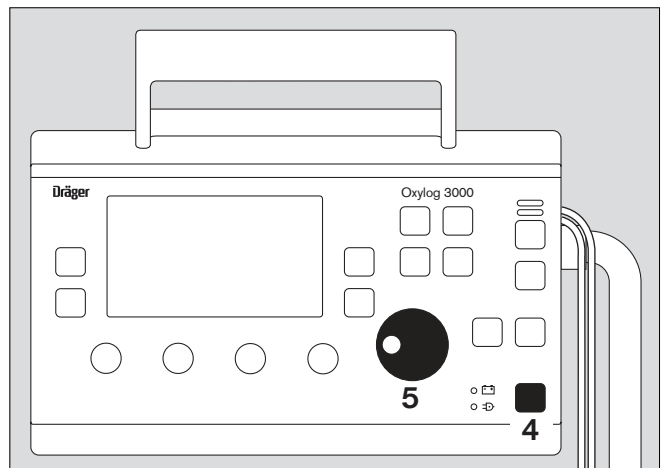



11937171

- Select »Device check« in main menu and confirm.
The device check can be ended at any time by pressing the »Alarm Reset« key.

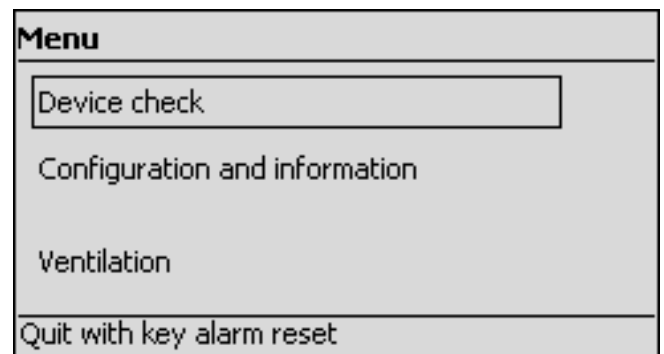

04137171

- Ensure that the gas supply has been connected.

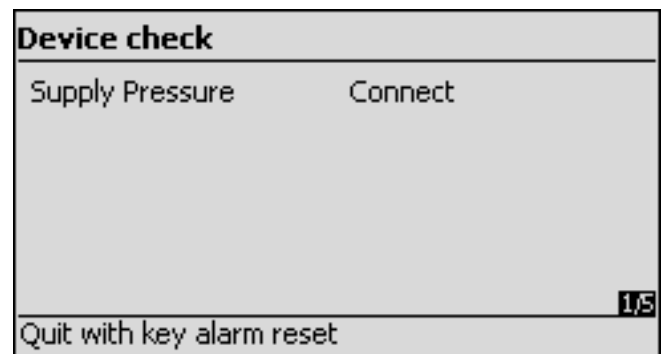

04237171

- Ensure that the correct gas type (O₂ or medical air) has been set and confirm.

If the wrong gas type has inadvertently been set:

- Press »Alarm Reset« key to cancel device check.
- Set correct gas type in configuration "Select gas supply" and restart device check.

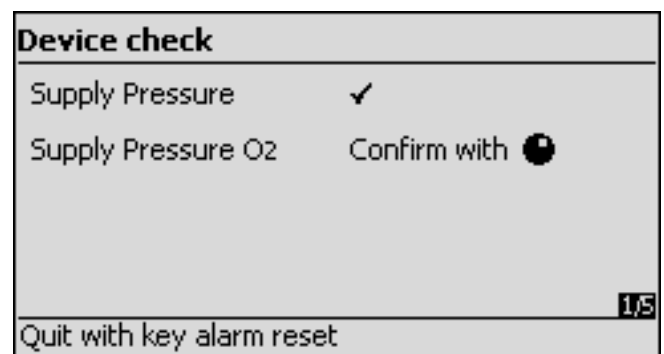

04437171

- Ensure that the test lung has been connected.

Oxylog 3000 automatically checks whether a test lung has been connected. The device check is aborted if a test lung is not detected within one minute.

The check is continued when Oxylog 3000 detects the test lung.

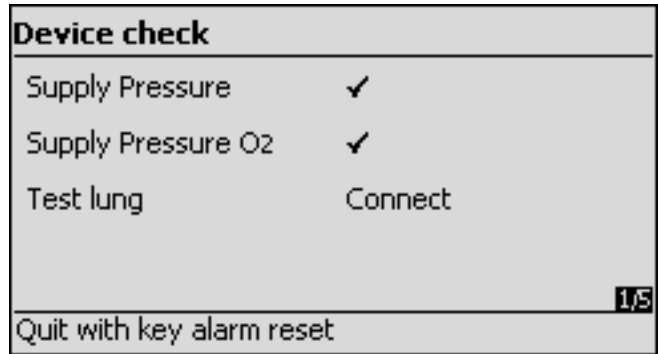

- Ensure that the configured hose system has been connected – either:
 - the disposable hose set or
 - the reusable hose set and confirm.
- Confirm the appropriate hose set and the second page of the device check appears.

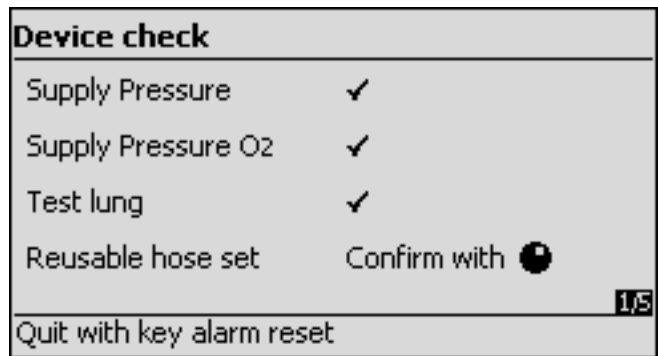

If the wrong hose set has inadvertently been configured:

- Press »Alarm Reset« key to cancel device check.
- Select correct hose set in "Customer Service Mode", "Select hose type", page 78, and
- restart device check.

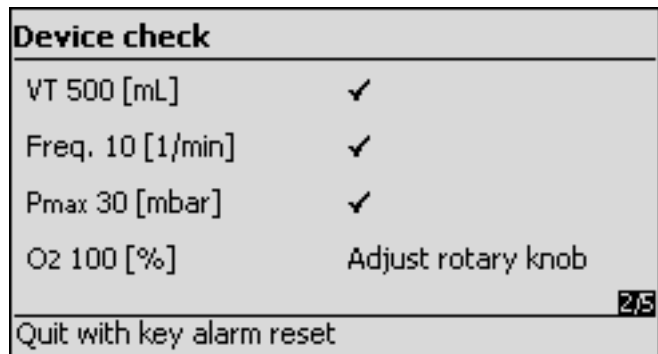

- 1 Set the controls below the screen to the required values.

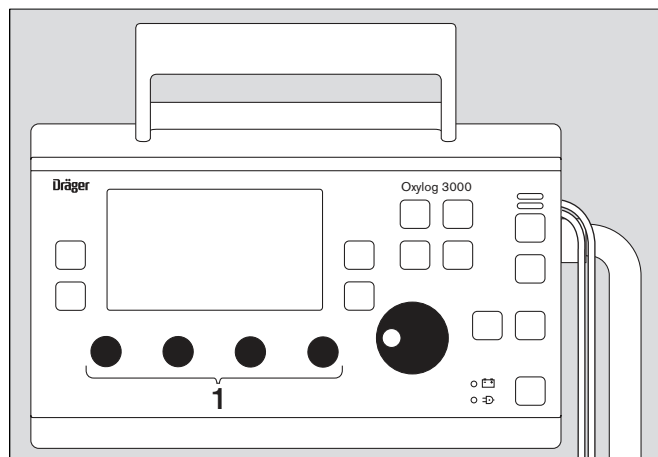

Oxylog 3000 successively activates the acoustic and visual alarm signals and prompts the operator to acknowledge each signal.

- Confirm acoustic and visual alarm signals.
The device check proceeds automatically.

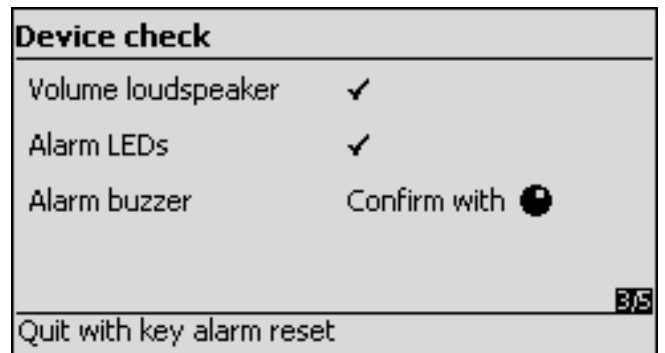

During the automatic test sequence, Oxylog 3000 checks the flow, pressure build-up and alarm signals. Corresponding sounds are heard.
The bar graph shows the progress made by the check.

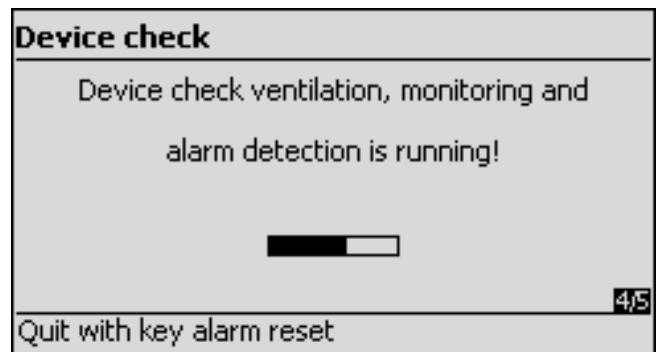

The result is displayed by Oxylog 3000:

- Confirm, and the system switches back to the menu screen.

If the device check cannot be completed successfully:

- Consult the section "Error messages during device check", page 30.
- Check configuration, page 51 onwards.
- Consult the chapter "Fault – Cause – Remedy", page 53.
- Call DrägerService.
- Assemble the Oxylog 3000 ready for operation, page 16 onwards.
- Connect to power supply and gas supply, page 19 onwards.

Start the ventilator:

- Select »Ventilation« and confirm
- or
- press »Alarm Reset« key.

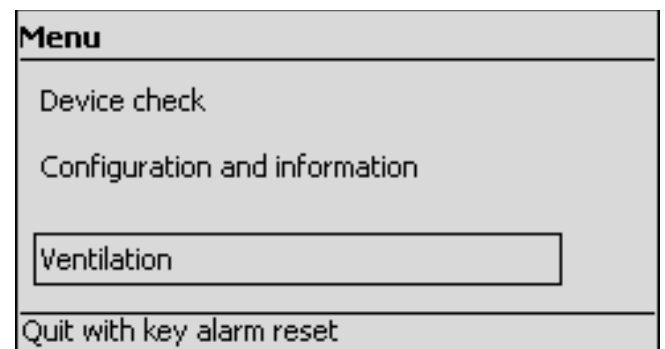
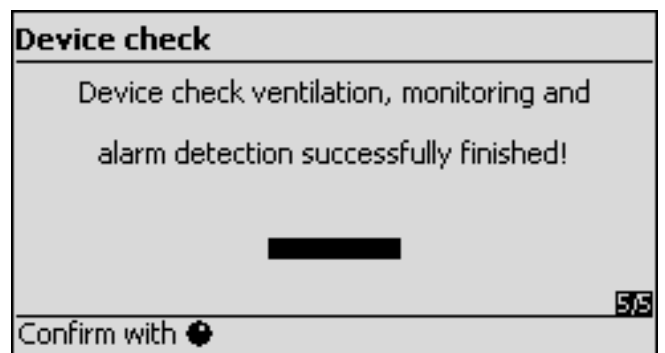

Error messages during device check

Message	Cause	Remedy
No communication control- / charge-board	Device defective.	Call DrägerService.
System leakage	Leak in ventilation hose and/or test lung.	Check hoses, breathing valve, flow sensor and test lung for leaks and replace if necessary.
	Internal leak in system.	Call DrägerService.
No testlung	Test lung not connected or major leakage.	Connect test lung. Check hoses, breathing valve, flow sensor and test lung for leaks and replace if necessary.
Breathing valve inop	Breathing valve has malfunctioned.	Check correct condition of breathing valve including diaphragm and rubber disc; fit a new breathing valve if necessary or use a new disposable hose set.
Pressure measurement inop	The ventilation hose set has not been connected correctly.	Connect ventilation hose set correctly.
	Pressure measurement is implausible.	Call DrägerService.
PEEP valve inop	Internal leak in system.	Check hoses, breathing valve, flow sensor and test lung for leaks and replace if necessary.
	Device defective.	Call DrägerService.
Flow measurement inop	Flow measurement implausible.	Replace flow sensor. Call DrägerService.

Operation	32
Starting operation	32
Preparing ventilation mode	32
IPPV (CMV), IPPVAssist (CMVAssist)	33
SIMV, SIMV/ASB (SIMV/PS)	36
BIPAP (PCV+), BIPAP/ASB (PCV+/PS)*	37
CPAP, CPAP/ASB (CPAP/PS)	38
Apnoea ventilation	39
NIV – Non-invasive ventilation Mask ventilation	41
O2 concentration without optional "O2 blending"	42
O2 concentration with optional "O2 blending" (40 % to 100 %)	42
Setting alarm limits	44
In the Event of an Alarm	45
Warning	45
Caution	45
Advisory	46
Suppress alarm tones	46
In the event of a gas failure	46
Displaying curves and measured values	47
Special functions	48
Calibration	50
Screen brightness	50
Shutdown	50
Displaying configuration and information	51

Operation

Check readiness for operation, page 26.

Starting operation

Switching on

- 1 Briefly press the » ⏻ « key.
Oxylog 3000 carries out the self-test.
- Wait for the 5 second self-test to be completed.

Upon expiry of the self-test, the ventilator automatically starts ventilation with the default settings.

Manufacturer's default settings:

- Ventilation mode **IPPV (CMV)**
- Ventilation time ratio **I:E = 1:1.5**
- Positive end expiratory pressure **PEEP = 5 mbar**
- Plateau time **Tplat = 0%**
- **Trigger = OFF.**

The manufacturer's default settings can be adjusted in "Customer Service Mode", "Set startup settings", page 77.

During the self-test, the system briefly displays the starting page with the software version and a prompt for the operator to select the configuration menu or to activate the device check by pressing the rotary knob.

The bar graph indicates the progress made in the self-test.

The standard screen with pressure curve and settings window is displayed if the central rotary knob is not pressed.

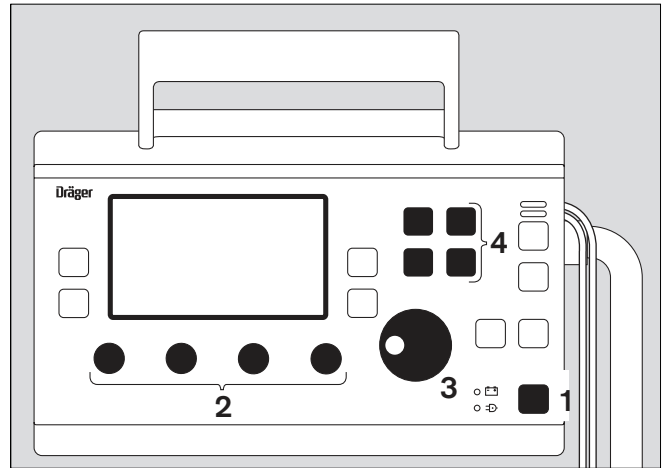

Preparing ventilation mode

Set ventilation parameters

- 2 Set the required control below the screen or
- 3 select, set and confirm a parameter on the screen.

The former settings are retained if confirmation is not received within 15 seconds. Attention is drawn to this fact by the advisory message "! Settings not confirmed".

If extreme values are set which must be confirmed, an acoustic alarm sounds with an advisory message in the information window.

When changing to another ventilation mode, values cannot be preset for the new ventilation mode.

To activate the ventilation mode

- 4 press the key for the ventilation mode for approx. 3 seconds,
or
- 4 briefly press the key for the ventilation mode and confirm.

The new ventilation mode selected is now effective.

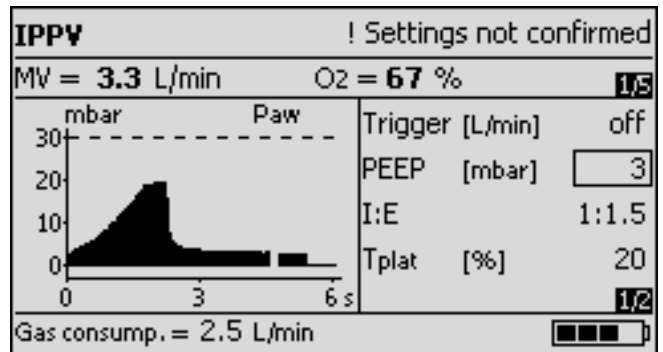

IPPV (CMV), IPPVAssist (CMVAssist)

IPPV – Intermittent Positive Pressure Ventilation

Volume-controlled ventilation with fixed mandatory minute volume MV, set with tidal volume VT and frequency Freq.

For patients without spontaneous breathing, see details on page 96 onwards.

IPPVAssist – Intermittent Positive Pressure Ventilation Assisted

For patients with partial spontaneous breathing.

For synchronisation with the patient's spontaneous breathing.

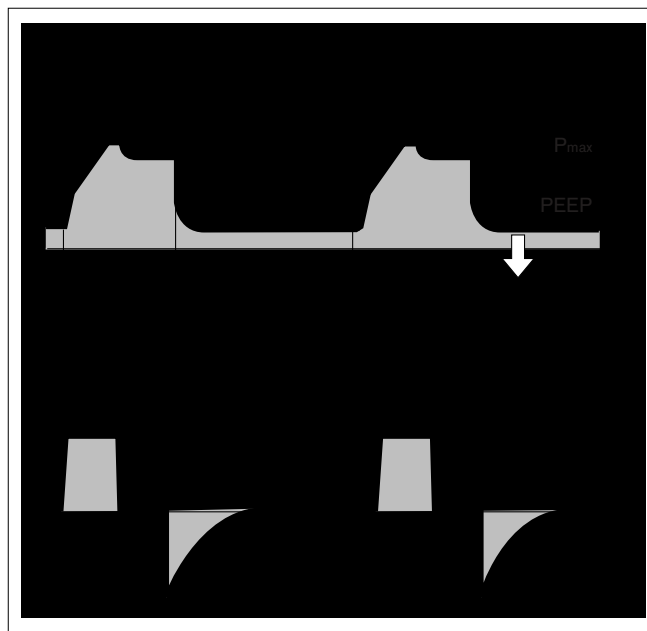

Set ventilation pattern with the controls below the screen:

- Tidal volume »VT«
- Ventilation frequency »Freq.«
(minimum possible frequency: 5 per min.)
- Maximum airway pressure »Pmax«
- O2 concentration »O2«.

The following can be set on the screen:

- Ventilation time ratio »I:E«
- Positive end expiratory pressure »PEEP«
- Plateau time »Tplat«, in % of the inspiration time.

When setting the ventilation frequency Freq., tidal volume VT or ventilation time ratio I:E, the associated values for inspiration flow and inspiration time Tinsp. are automatically displayed in the information window.

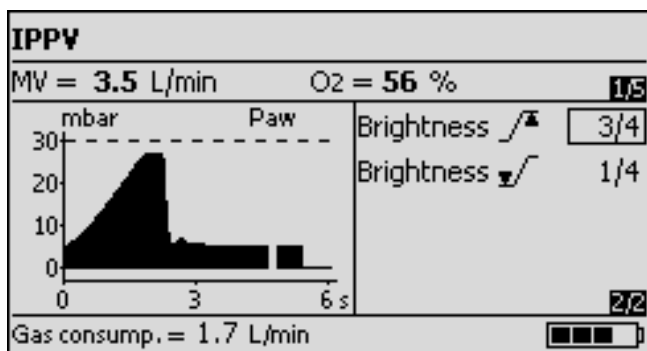
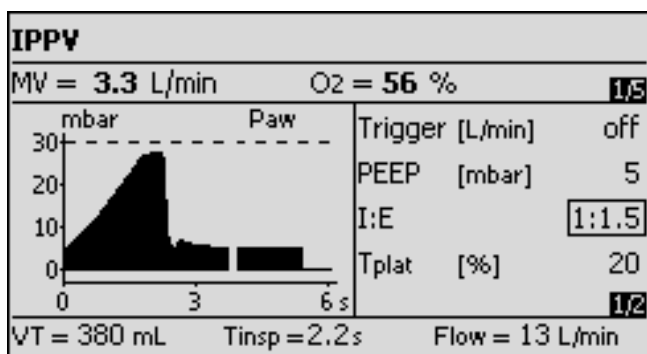

IPPV (CMV) can be extended to include the trigger function IPPV_{Assist} (CMV_{Assist}):

Trigger (IPPV_{Assist})

For synchronisation with the patient's spontaneous breathing efforts.

The mandatory ventilation strokes are synchronised with the patient's spontaneous breathing efforts when the trigger is activated and the trigger sensitivity set.

The actual frequency may be higher than the set ventilation frequency Freq. in this case.

The trigger can be deactivated if synchronisation with the patient's spontaneous breathing efforts is not desired. Successful patient triggering is briefly indicated by an asterisk (*) in the middle of the top line of the screen.

Activating/setting the trigger:

- 1 Press key »Set. ▷▷ « until the parameter trigger is displayed.
 - Select line »Trigger« on the screen and then set and confirm the value.
Small value = high sensitivity
- The ventilation mode IPPV_{Assist} is displayed on the screen.

Deactivate trigger:

- Set a value less than 3 L/min or greater than 15 L/min,
- display **off** confirm.

The last effective trigger value is adopted by the ventilator when changing from IPPV_{Assist} to SIMV, BIPAP or CPAP/ASB.

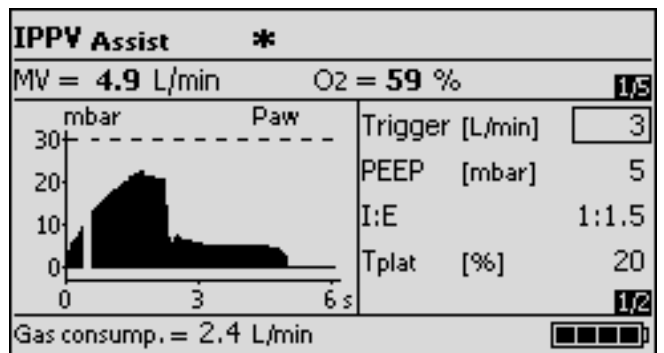
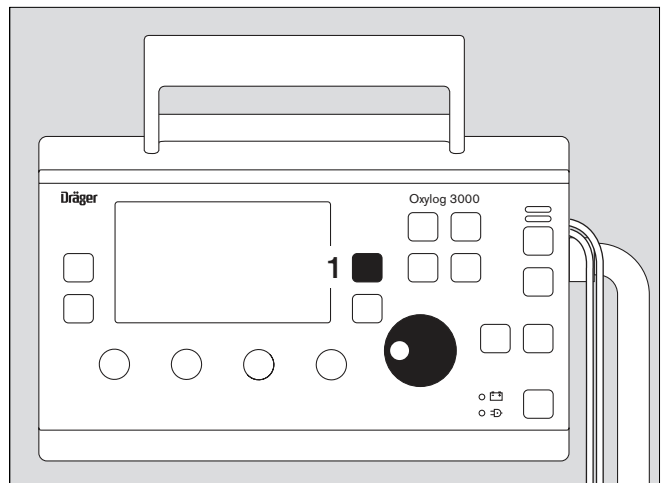

For heart-lung resuscitation

The airway pressure P_{aw} is limited to the set P_{max} value by Oxylog 3000 without ending inspiration prematurely (pressure-limited, inconstant-volume ventilation when P_{max} is reached).

P_{max} should be set to maximum in order to apply the maximum possible minute volume.

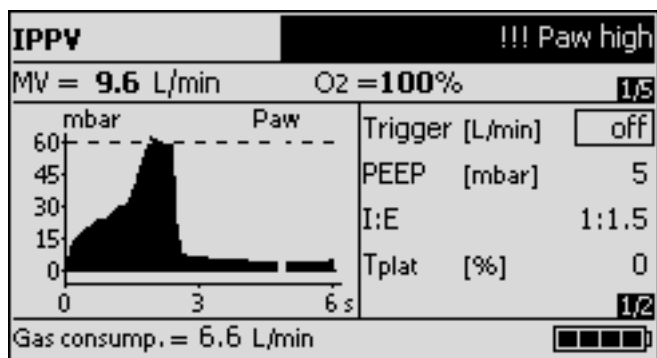

Setting alarm limits, page 44.

SIMV, SIMV/ASB (SIMV/PS)*

Synchronised Intermittent Mandatory Ventilation Assisted Spontaneous Breathing

Fixed mandatory minute volume MV set with tidal volume VT and ventilation frequency Freq. The patient can breathe spontaneously between the mandatory ventilation strokes and thus contribute to the total minute volume. Spontaneous breathing can be assisted with ASB.

For patients with inadequate spontaneous breathing or for patients who are to be weaned by gradually reducing the mandatory portion of the total minute volume.

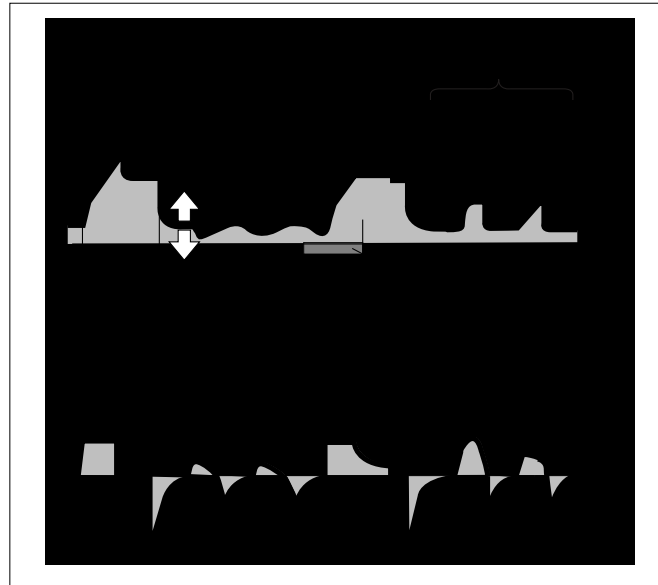

Set ventilation pattern with the controls below the screen:

- Tidal volume »VT«
- Frequency »Freq.«
- Maximum airway pressure »Pmax«
- O2 concentration »O2«.

The following are set on the screen:

- Inspiration time »Tinsp«
- Positive end expiratory pressure »PEEP«
- Sensitivity »Trigger«.

Successful patient triggering is briefly indicated by an asterisk (*) in the middle of the top line of the screen.

When setting the ventilation frequency Freq., tidal volume VT or inspiration time Tinsp., the associated values for inspiration flow and ventilation time ratio I:E are automatically displayed in the information window.

Additional functions can be set on the screen:

- Pressure support »Δ ASB« via PEEP
- Pressure rise time »Ramp«
 - steep ramp = short pressure rise time
 - flat ramp = long pressure rise time
- Plateau time »Tplat«.

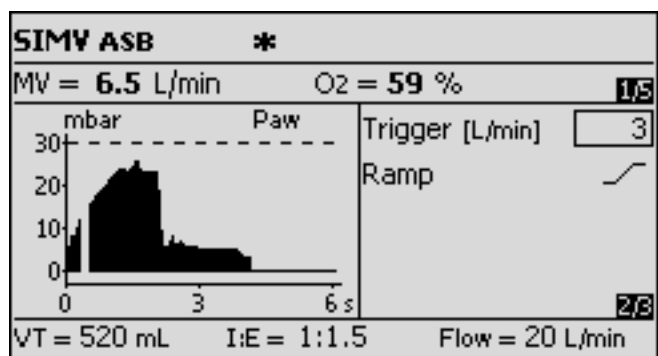
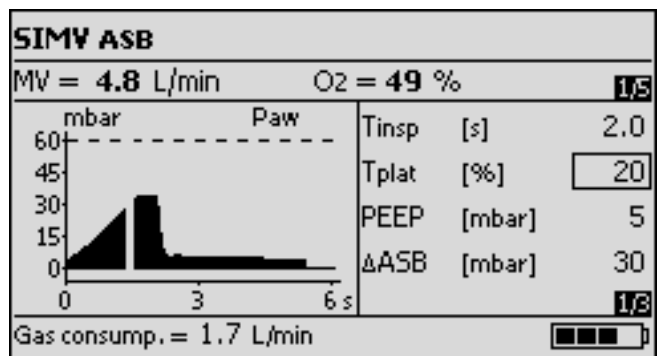

Setting alarm limits, page 44.

* SIMV / ASB is an optional ventilation mode

BIPAP (PCV+)*, BIPAP/ASB (PCV+/PS)*

Biphasic Positive Airway Pressure Assisted Spontaneous Breathing

Pressure-controlled ventilation combined with spontaneous breathing throughout the breathing cycle and variable pressure support at CPAP level.

The mandatory portion of the total minute volume MV is set via the inspiratory pressure P_{insp}, PEEP and ventilation frequency Freq.

Used for patients without spontaneous breathing, to spontaneously breathing patients shortly before extubation. The patient is weaned by gradually reducing the mandatory portion of the total minute volume MV and by reducing the pressure support ΔASB.

Refer to the description on page 99 for details.

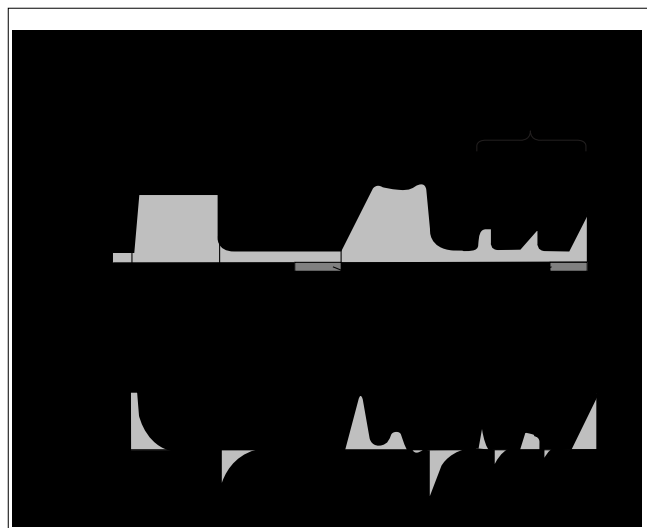

Set ventilation pattern with the controls below the screen:

- Ventilation frequency »Freq.«
- Maximum airway pressure »Pmax«
- O₂ concentration »O₂«.

The following can be set on the screen:

- Inspiration time »T_{insp}«
- Inspiratory pressure »P_{insp}«
- Positive end expiratory pressure »PEEP«
- Sensitivity »Trigger«
Successful patient triggering is briefly indicated by an asterisk (*) in the middle of the top line of the screen.
- Pressure rise time »Ramp« (effective for the BIPAP stroke and pressure support »ΔASB«).

The following can additionally be set on the screen for BIPAP/ASB:

- Pressure support »ΔASB« via PEEP.

BIPAP, BIPAP/ASB can be extended to include the application mode NIV – Non-invasive ventilation, see page 41:

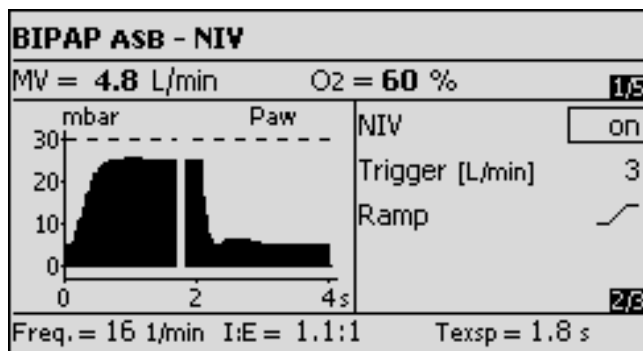
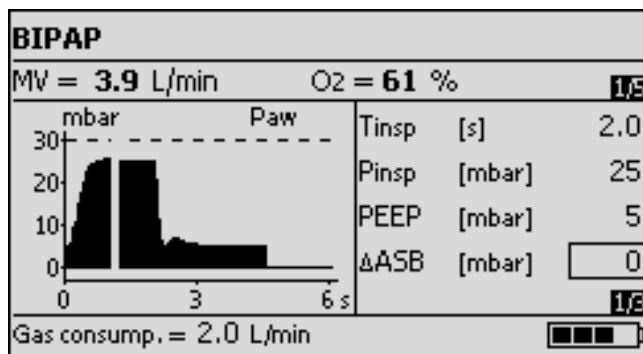

Setting alarm limits, page 44.

* BIPAP and BIPAP/ASB are optional ventilation modes

CPAP, CPAP/ASB (CPAP/PS)*

Continuous Positive Airway Pressure Assisted Spontaneous Breathing

For patients with adequate spontaneous breathing.

Spontaneous breathing at an elevated pressure level to increase the functional residual capacity FRC.

Spontaneous breathing can be assisted with ASB.

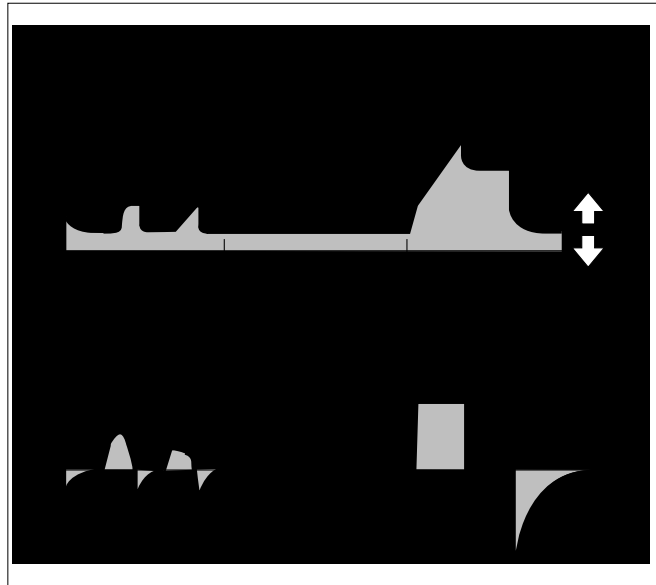

Set ventilation pattern with the controls below the screen:

- Maximum airway pressure »Pmax«
- O₂ concentration »O₂«.

The following can be set on the screen:

- Positive end expiratory pressure »PEEP«.

The following can additionally be set on the screen for CPAP/ASB:

- Sensitivity »Trigger« (for synchronisation with the patient's spontaneous breathing efforts).
Successful patient triggering is briefly indicated by an asterisk (*) in the middle of the top line of the screen.
- Pressure support »Δ ASB« via PEEP
- Pressure rise time »Ramp« (for pressure support Δ ASB)

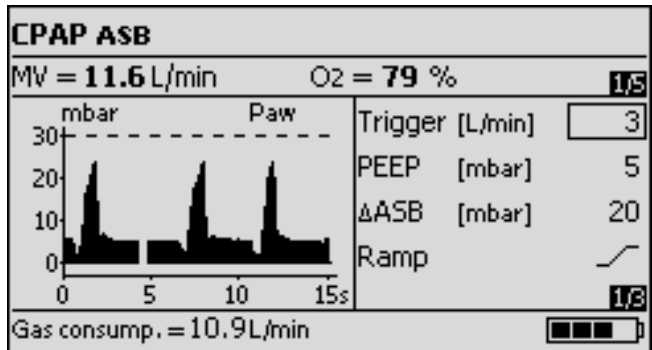

CPAP, CPAP/ASB can be extended to include the following application modes:

- Apnoea ventilation, see page 39.
- NIV – Non-invasive ventilation, see page 41.

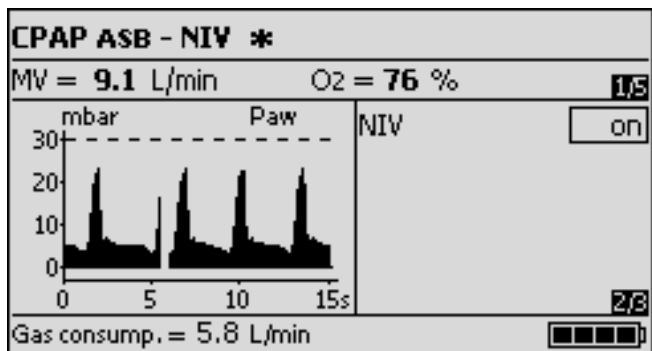

Setting alarm limits, page 44.

* CPAP / ASB is an optional ventilation mode

Apnoea ventilation

For automatically switching over to volume-controlled mandatory ventilation (SIMV) in the event of an apnoea – only effective in ventilation mode CPAP.

When an apnoea occurs, the device simultaneously outputs an alarm signal and starts volume-controlled mandatory ventilation with the parameters frequency »fApnoea«, tidal volume »VTApnoea« and the maximum airway pressure »Pmax«, upon expiry of the set alarm time "TApnoea". The ventilation time ratio I:E is invariably set to 1:1.5. The plateau time »Tplat« is 0. The patient can breathe spontaneously during apnoea ventilation. The mandatory frequency »fApnoea« remains constant.

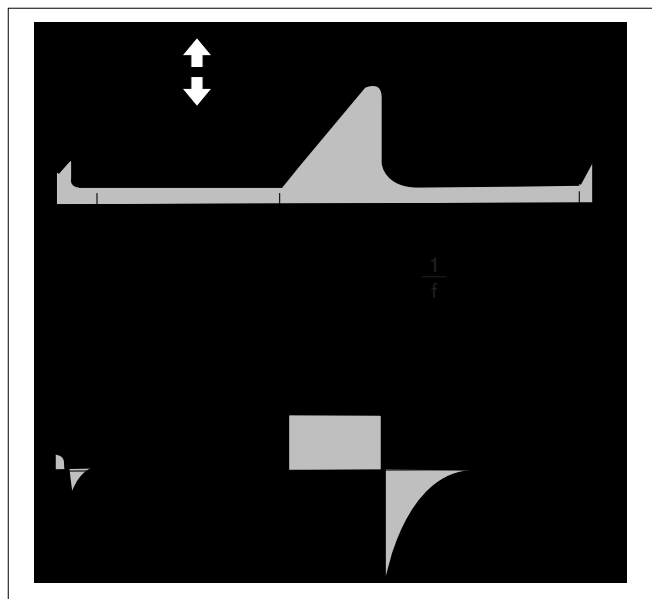

Setting apnoea ventilation

On the screen:

- 1 Press »Set. ▷▷« key until screen page **2/3** appears.

To switch apnoea ventilation on:

- Set »TApnoea« to a value between 15 and 60 seconds.

The parameters fApnoea and VTApnoea, which are required for setting apnoea ventilation, are now displayed:

- Set »fApnoea« and »VTApnoea«.

- 2 The selected maximum airway pressure »Pmax« must be such as to allow pressure to build up for the volume-controlled ventilation stroke.

The ventilation time ratio I:E = 1:1.5 and the plateau time Tplat = 0 are invariable during apnoea ventilation.

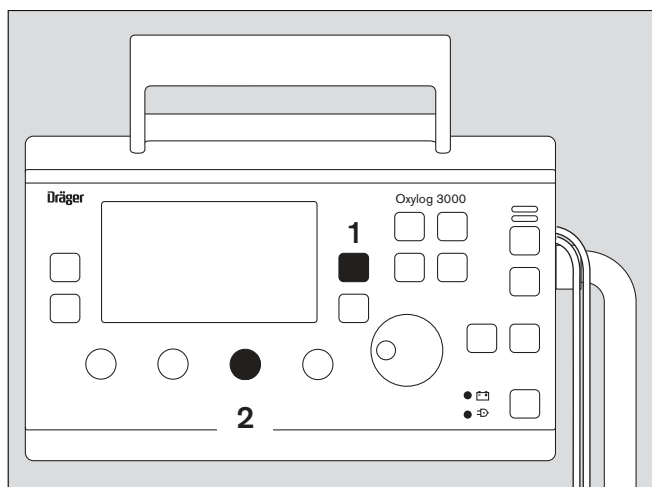

To switch apnoea ventilation off:

- Set »TApnoea« to off.

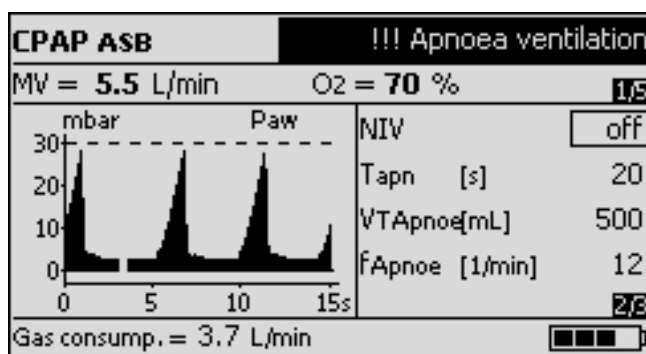

To end apnoea ventilation:

- Press the »**Alarm Reset**« key.

The ventilator continues operation with the original ventilation mode and with the original ventilation parameters set (CPAP).

The manufacturer's settings $f_{\text{Apnoea}} = 12$ 1/min and $VT_{\text{Apnoea}} = 500$ ml can be changed in "Customer Service Mode", see page 77.

Apnoea ventilation can only be activated in ventilation mode CPAP without NIV. Apnoea ventilation is not available in any of the other pressure-controlled ventilation forms.

- **The minimum ventilation required by the patient must be assured via the lower alarm limit MV ■■■.**

Setting alarm limits, page 44.

NIV – Non-invasive ventilation

Mask ventilation

NIV can only be activated as a supplementary function in the pressure-controlled ventilation modes BIPAP (PCV+), BIPAP/ASB (PCV+/PS), CPAP, CPAP/ASB (CPAP/PS).

Mask leakages are detected by the device, compensated and included in the displayed flow curve and measured values for V_T and MV.

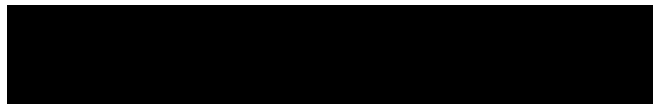

Use of NIV



To switch on NIV

- Press »Set. ▷▷« key until screen page 2/2 appears.
- Activate line »NIV off«
- Select »on« and confirm

The supplement NIV appears in the top line of the screen.

Oxylog 3000 automatically adjusts to the requirements of mask ventilation. Leakage flows are compensated automatically and the leakage alarm is inactive.

- The minimum ventilation required for the patient must be assured by setting the lower alarm limit »MV []«.

Apnoea ventilation is not permitted by the ventilator when NIV is active.

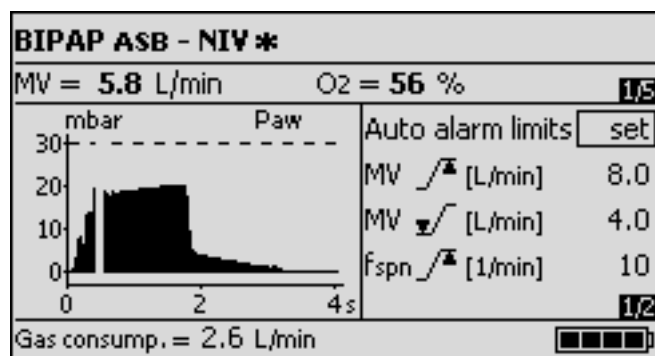
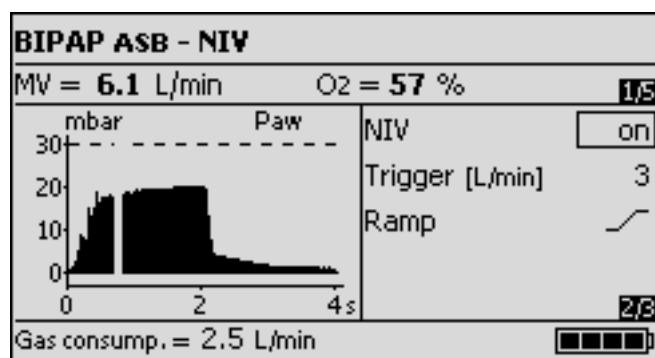

O₂ concentration without optional "O₂ blending"

- 1 The O₂ concentration can be set to 60 % (comparable to "Air Mix" on Oxylog 2000) or 100 % (comparable to "No Air Mix" on Oxylog 2000). Other settings are not possible.

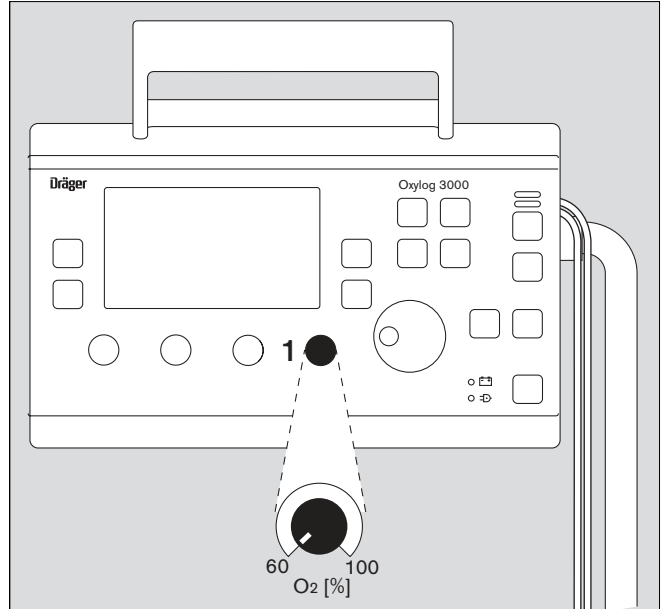

O₂ concentration with optional "O₂ blending" (40 % to 100 %*)

The O₂ concentration can be infinitely varied between 40 % and 100 %, regardless of the ventilation mode. With the injector principle realised in the Oxylog 3000, lower O₂ concentrations of up to 40 % can be produced by drawing in ambient air in the frequently used flow range from 9 to 35 L/min.

If Oxylog 3000 must deliver inspiratory flows outside this range or at a high mean airway pressure P_{mean}, these will be applied with a higher O₂ concentration by the device.

The mean O₂ concentration realized is displayed in the measured values window as a calculated value based on the measured air intake and total flow.

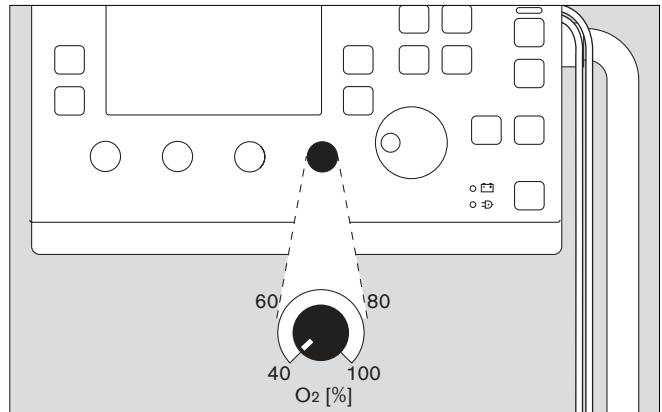

If Oxylog 3000 realizes on account of the O₂ display that the set O₂ concentration cannot be achieved, it will signal "Check settings O₂" and prompt the user to correct the setting.

Then:

- Correct setting via control »O₂«.

When the O₂ concentration has been set, the measured value will be displayed after approx. 30 seconds. The message "Check settings O₂" is displayed with a delay after setting the value.

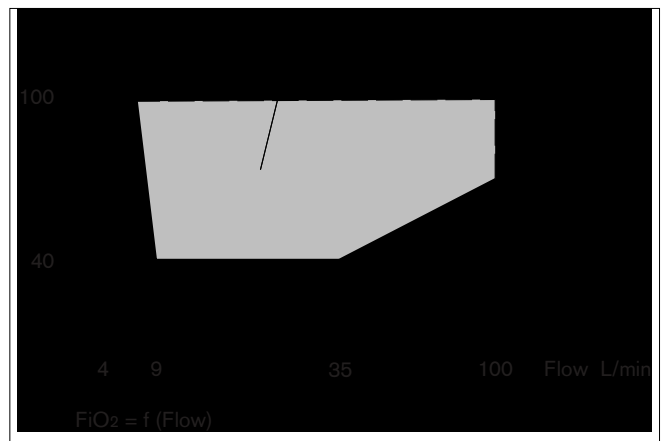

* O₂ blending is optional. In the basic version, it is only possible to change over between values of 60 % and 100 %.

When patients who are spontaneously breathing, the achievable O₂ concentration will depend on the profile of the inspiratory flow. Even if this profile is changed, the message "Check settings O₂" may appear after some time.

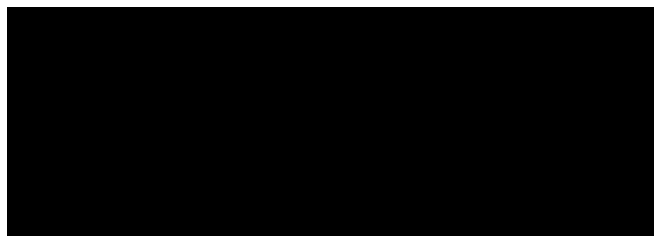

Setting alarm limits

Upper alarm limit for Paw

Pressure limitation with Pmax

Regardless of the set ventilation mode, the airway pressure is controlled by the ventilator and limited to the set maximum inspiratory pressure Pmax. Pmax appears in the pressure curve as a dashed line. When this dashed line is reached, Oxylog 3000 outputs a "!!! Paw high" alarm. The volume-controlled stroke cannot be applied completely (ventilation with inconstant volume).

- 1 Set the maximum airway pressure Pmax via the »Pmax« control.

The airway pressure is limited by Oxylog 3000 when Pmax is reached; inspiration is not ended prematurely.

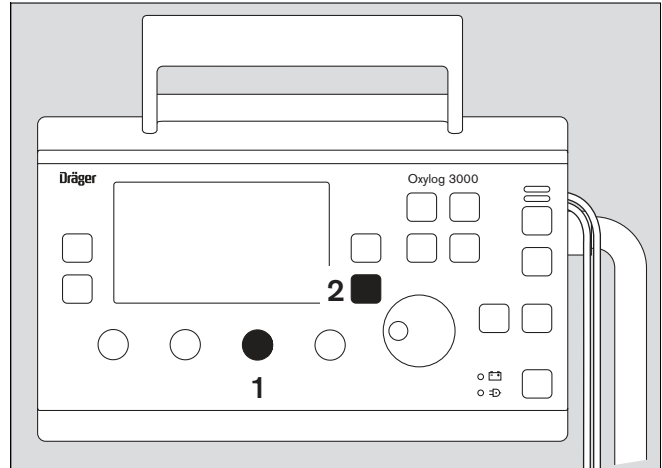

Lower alarm limit for Paw

A lower alarm limit need not be set for the airway pressure Paw. Oxylog 3000 automatically generates an alarm when it no longer detects a pressure difference of more than 5 mbar between inspiratory and expiratory pressure.

To set alarm limits for MV and fspn

- 2 Press key »Alarm ▷▷«.

Display example »Alarms« screen with variable alarm limits

- = lower alarm limit
- = upper alarm limit

Alarm	Range
MV ■	2 to 41 L/min
MV ■	0.5 to 40 L/min
fspn ■	10 to 100 1/min

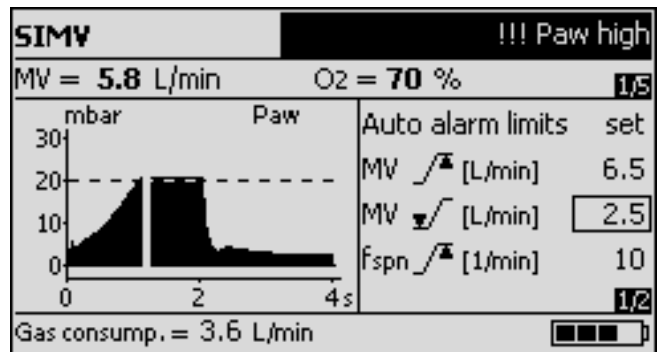

Example: Setting the upper alarm limit for MV.

- Select and activate the line »MV ■« on the screen.
- Set and confirm the value.

Setting alarm limits automatically

The function »Auto alarm limits« sets the alarm limits on the basis of the following actual measured values at the time of activation:

- MV ■ : Measured value MV +2 L/min
- MV ■ : Measured value MV -2 L/min
- fspn ■ : Measured value Frequency + 5 1/min

This automatic selection of alarm limits is performed only **once** when confirmed via the rotary knob. The alarm limits refer to the current measured values for MV and fspn.

In the Event of an Alarm

- 1 the red lamp flashes
or
- 2 the yellow lamp flashes.
- 3 The alarm message appears on the right of the top line on the screen.

Oxylog 3000 assigns corresponding priority to the alarm message, highlights the text with the appropriate number of exclamation marks and generates different tone sequences for the respective alarms.

!!! = Warning

!! = Caution

! = Advisory

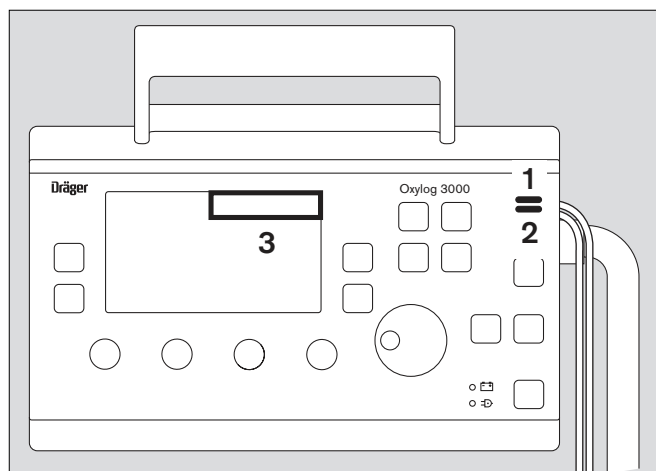

Warning

An alarm with top priority

- 1 Red alarm lamp flashes.

Warnings are highlighted by three exclamation marks and displayed in inverted form.

Example: **!!! Apnoea**

Oxylog 3000 generates a sequence of five tones which sounds twice and is repeated every 7.5 seconds.

Caution

An alarm of medium priority.

- 2 Yellow alarm lamp flashes.

Caution messages are highlighted by two exclamation marks.

Example: **!! No int. battery ?**

Oxylog 3000 generates a three-tone sequence which is repeated every 20 seconds.

Advisory

Low-priority alarm.

1 Yellow alarm lamp lights up.

Advisory messages are identified by one exclamation mark.

Example:

! Settings not confirmed

Oxylog 3000 generates a two-tone alarm sequence which only sounds once.

- Refer to the list "Fault – Cause – Remedy" on page 53 for information on how to remedy the faults.

When the fault has been remedied

the alarm tone is cancelled.

Alarms which have been remedied remain on display and can be acknowledged (reset):

2 Press the »Alarm Reset« key.

3 The alarm message is deleted from the screen.

Every alarm which has been remedied but not acknowledged will be overwritten and cancelled by a new alarm or advisory message.

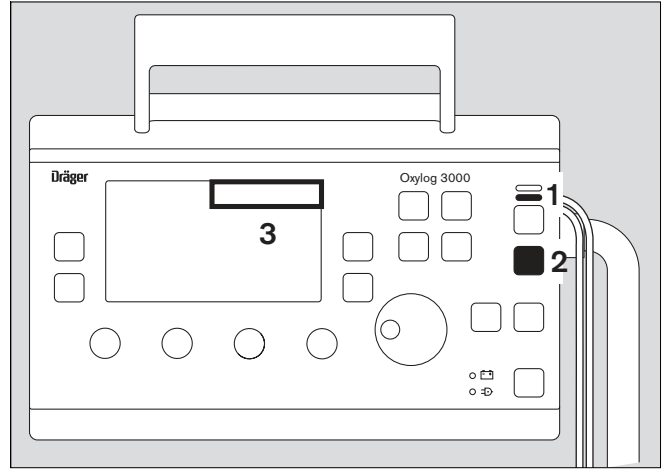

Suppress alarm tones

for max. 2 minutes:

- 4 Press key »  « its yellow lamp lights up and all alarm tones are suppressed for approx. 2 minutes. Alarm tones are once again output by the device after these 2 minutes.

If alarm tones are to be heard again before the 2 minutes have expired:

- 4 press key »  « again and its lamp goes out.

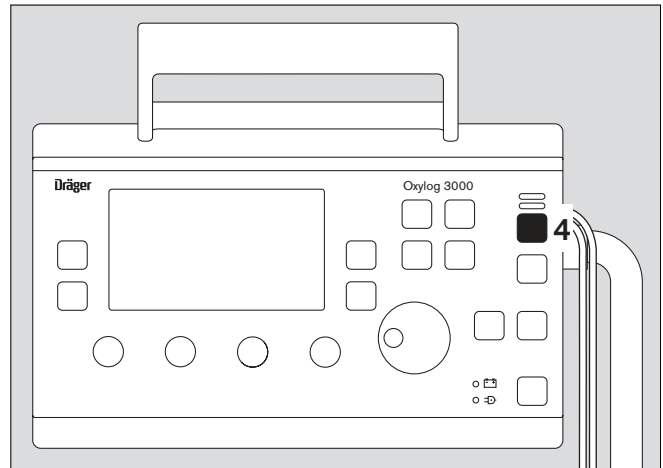

In the event of a gas failure

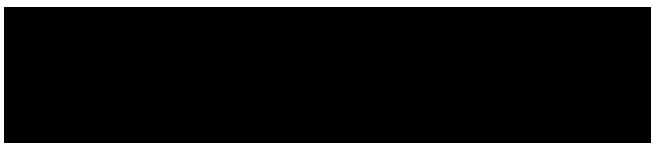

Displaying curves and measured values

The main page

displays the airway pressure curve Paw(t) or flow curve Flow(t) and two relevant measured values.

To display a different curve

- 1 Press »Curves  « key.

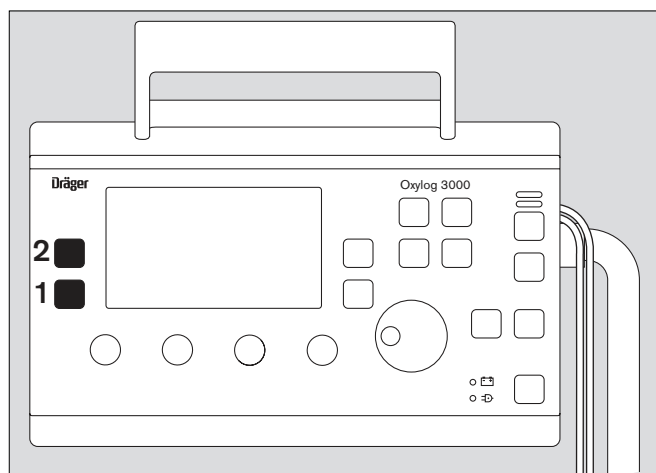

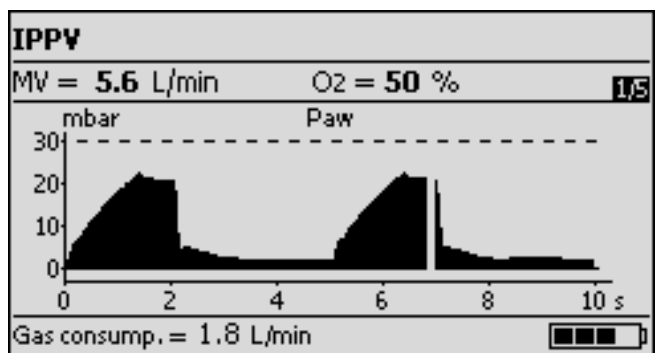

Example: airway pressure curve Paw(t)

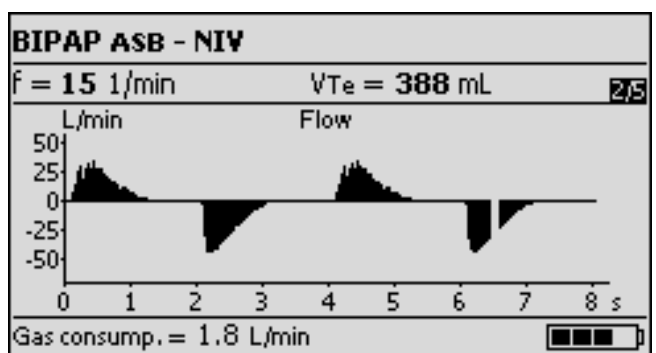

Example: flow curve (t)



Displaying other measured values

- 2 Press »Values   « key: the next page is displayed on the device.

The following pairs of measured values are displayed in the default setting:

1. MV, O₂
2. f, V_{Te}
3. PEEP, P_{mean}
4. P_{peak}, P_{plat}
5. MV_{spn}, f_{spn}

The displays can be configured as required in Customer Service Mode, page 79.

Special functions

Manual inspiration / Inspiration hold

Inspiration Hold for volume-controlled strokes:

Regardless of the time at which it is started, an automatic ventilation stroke can be extended for up to max. 15 seconds (in IPPV, IPPV_{Assist}, SIMV, SIMVASB).

Or

manual inspiration:

A ventilation stroke can be started manually between two automatic strokes and held for up to max. 15 seconds.

The pattern of the manually started ventilation stroke corresponds with the set ventilation mode.

For IPPV (CMV), SIMV:

Volume-controlled ventilation stroke determined by the settings »VT« and »T_{insp}«, as well as »I:E«.

For BIPAP (PCV+) , BIPAP/ASB (PCV+/PS):

The pressure-controlled ventilation stroke is determined by the settings »P_{insp}« and »T_{insp}«.

For CPAP/ASB (CPAP/PS):

The pressure-controlled ventilation stroke is determined by the setting »Δ ASB«.

To activate Manual inspiration or Inspiration hold

1 Press key »Insp. hold« for as long as inspiration is required.

Oxylog 3000 will either extend the momentary automatic ventilation stroke accordingly or start a new ventilation stroke and hold it for up to max. 15 seconds.

100 % O₂ (optional)

To apply 100 % O₂ for 3 minutes regardless of the momentarily set value.

2 Briefly press »100 % O₂« key; its LED lights up for 3 minutes.

The set value is resumed by the ventilator upon expiry of these 3 minutes.

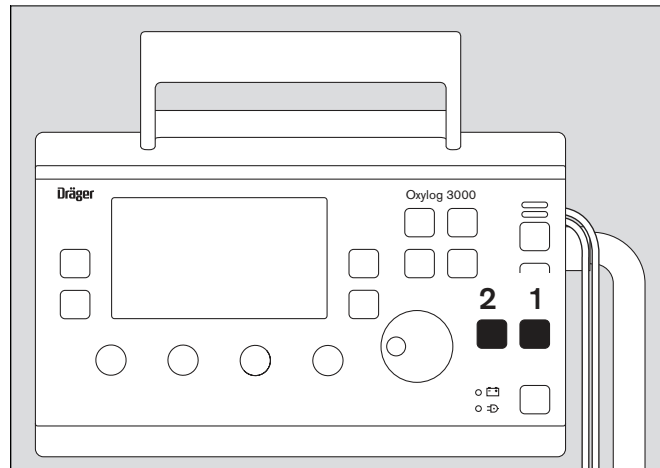

O₂ inhalation (optional)

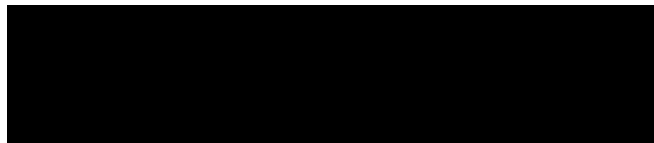

If stenosis occurs, the flow is interrupted by the ventilator for 500 ms at an airway pressure of 30 mbar and the airway pressure is reduced to 0 mbar.
The "!!! Paw high" alarm is active.

- The spontaneously breathing patient may only be connected to the device via an inhalation mask.

To activate O₂ inhalation:

- 1 Press and hold key »O₂-Inhalation« for approx. 3 seconds or
- 1 briefly press key »O₂-Inhalation« and confirm.
- 2 Connect the inhalation mask to the inspiration socket via an adapter (see accessories).

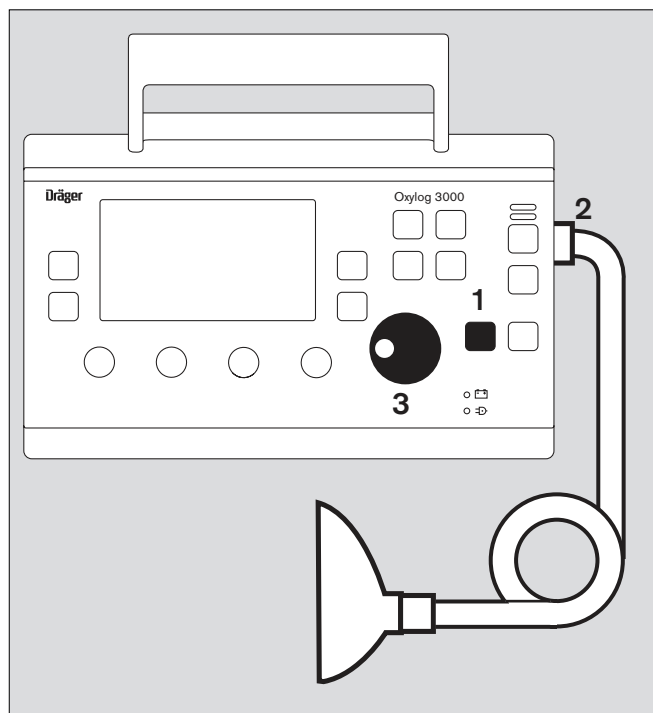

Display (example): »O₂-Inhalation«

O₂ inhalation is performed with the previously effective setting.

- 3 Set and confirm the required O₂ flow via the central rotary knob.

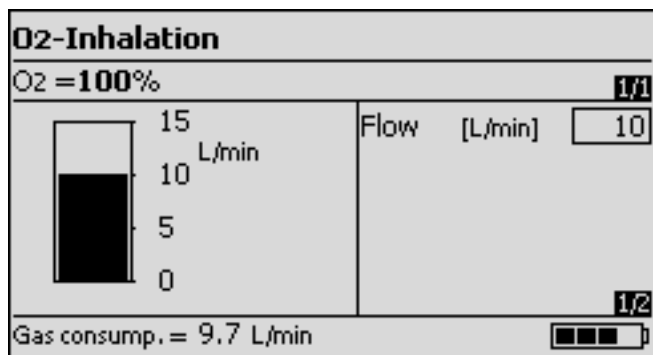



Calibration

The pressure sensors and flow measurements are automatically calibrated by the device at regular intervals.

The saved calibration values are retained even when the device is switched off.

Screen brightness

The screen brightness levels can be defined independently of the ventilation mode for battery and mains operation on the last page of the "Setting" menu:

- The brightness setting  is active in both mains and battery operation when making settings on the ventilator.
- The brightness setting  is active when operating with replaceable battery.

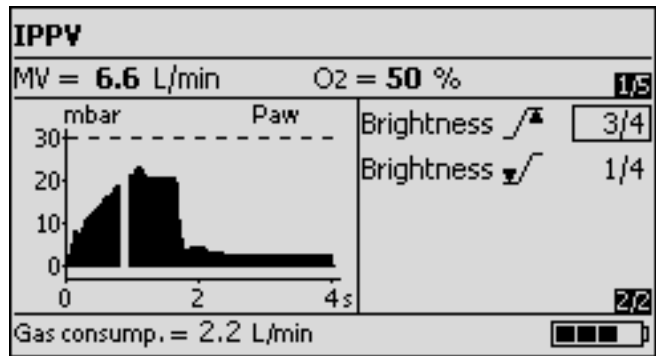

Shutdown

After disconnecting the patient:

Switch ventilator off:

- 1 Press key »« for 3 seconds. Its yellow lamp flashes and ventilation is subsequently ceased by the device.
- 2 The alarm
!!! Confirm device OFF with rotary knob
 must be acknowledged.

When O2 is supplied from a cylinder:



When medical gas is supplied from the pipeline system:

- Unplug probe.

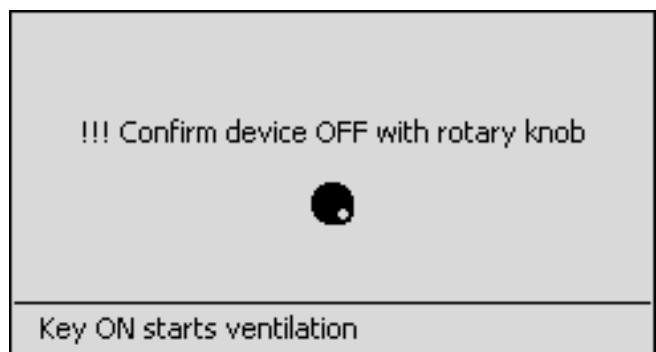
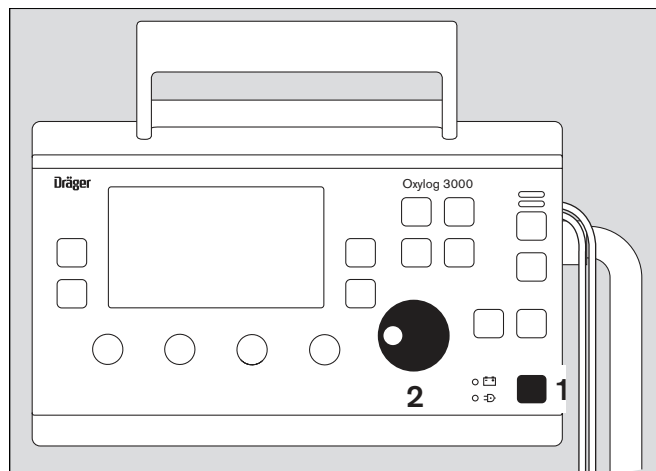

Displaying configuration and information

The following settings can be made for the application concerned via »**Configuration and information**«:

- Select language
- Select gas supply (O₂ or medical air)

The settings made under "Configuration" are retained even when the ventilator is switched off.

The following ventilator data can be displayed via »**Configuration and information**«:

- Identification No. (device ID)
- Total hours of operation (Total working hours)
- Hours of operation since the last inspection and maintenance (Hours since service time)
- Battery type and battery capacity

Set configuration parameters /display information

- 1 Switch Oxylog 3000 on = press the »« key.
The device runs through a self-test and the operator is prompted, on the display, to call up the configuration menu or device check:
Press rotary knob for device check and configuration
- 2 Confirm.

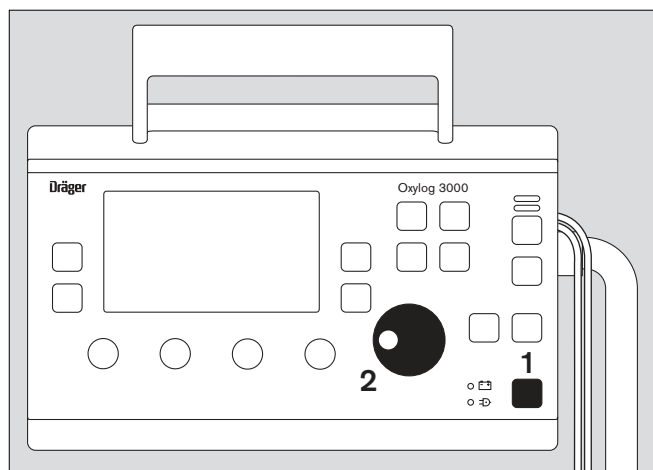

The main menu is then displayed:

- Select and confirm »**Configuration and information**«.

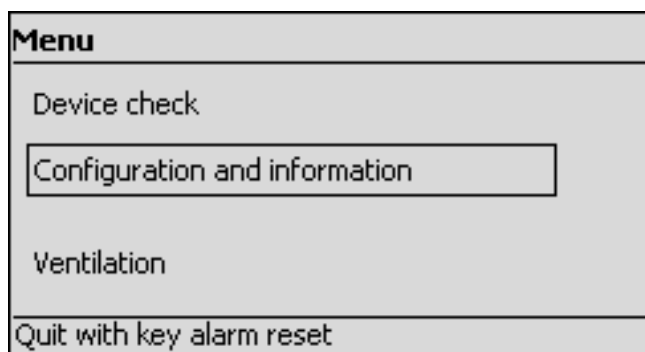

Set language

● Press key »Set. ▷▷ « to select the menu »**Configuration and information 1/2**«.

● Select and activate line »**Language**«.

The following languages are available:

- German
- English
- US-English
- French
- Spanish
- Swedish
- Portuguese
- Italian
- Dutch

● Select language and confirm.

The new language selected is immediately effective.

Configuration	
Language =	English Gas supply = O2
Device-ID:	11776329
Working hours:	231 h
Hours since service-time:	0 h
1/2	
Continue with key adjustment / quit with reset	

00637171

Set gas supply

● Press key »Set. ▷▷ « to select the menu »**Configuration and information 1/2**«.

● Select and activate line »**Gas supply**«.

O2 or medical air can be set.

● Set and confirm the required gas supply.

When medical air is selected, Oxylog 3000 will deliver a concentration of 21 % regardless of the set O2 concentration. However, the control »O2« can be set to 40 %, for example. In this way, Oxylog 3000 will use less medical air by additionally drawing in ambient air.

Configuration	
Language = English	Gas supply = O2
Device-ID:	11776329
Working hours:	231 h
Hours since service-time:	0 h
1/2	
Continue with key adjustment / quit with reset	

00637171

Display battery type

● Press key »Set. ▷▷ « to select the menu »**Configuration and information 2/2**«.

The performance data of the inserted battery are displayed on the device.

Information	
Manufacturer.:	EONE MOLI
Battery type:	LION ME202AF
Date:	07/01 Batt. cycles: 7
Design Cap.:	5400 mAh Act.capacity: 100 %
2/2	
Continue with key adjustment / quit with reset	

00637171



Fault – cause – remedy	54
Messages in the Alarms window	54
Messages in the information window	56

Fault – cause – remedy

Oxylog 3000 classifies error messages according to three priority levels and identifies these accordingly with the aid of exclamation marks:



!!! Warning = Message with top priority

!! Caution = Message with medium priority

! Advisory = Message with low priority

The messages are listed in alphabetical order. The following list is intended to assist in identifying and rectifying the underlying cause of any faults triggering an alarm.

Messages in the Alarms window

Message	Cause	Remedy
! 21% oxygen	The device has been set to medical air and may only be operated with medical air.	
!!! Apnoea	Spontaneous breathing by the patient has failed, or disconnection.	Ventilate in IPPV (CMV) mode. Ensure that hose connections are tight.
	Faulty flow sensor.	Replace flow sensor.
!!! Apnoea ventilation (only for CPAP)	The ventilator has automatically switched over to mandatory ventilation after detecting an apnoea (only in CPAP mode).	Check ventilation mode. Return to original ventilation mode: Press the »Alarm Reset« key.
!! Charge int. battery	Oxylog 3000 draws its power from the internal battery due to the absence of an external DC supply. Only a few minutes of operating time remain (typically 10 minutes).	The ventilator must immediately be reconnected to the mains supply, an onboard DC supply or a fully charged battery.
!! Check settings flow	The flow resulting from the settings for "Tidal volume V_T per unit time" is impossible.	Change tidal volume V_T or inspiratory time T_{insp} or ventilation time ratio I:E .
! Check settings O₂ (only for optional "O ₂ blending")	The set O ₂ concentration cannot be achieved with the set flow.	Adjust inspiratory flow or O ₂ concentration (in accordance with measured value).
!! Check settings time	The expiration time resulting from the settings for Freq. and I:E or T_{insp} is impossible.	Change Freq. or I:E or T_{insp} .
!!! Confirm device OFF with rotary knob	Key »  « has been pressed for 3 seconds.	To switch off: confirm. To continue ventilation, press key »  « again.
!!! Device failure	Technical defect.	Call DrägerService.
!! Flow measurement inop	Measurement hoses for flow measurement on patient side buckled, disconnected or leaking.	Ensure measurement hoses for flow measurement on patient side are connected correctly.
	Flow sensor defective.	Replace flow sensor.
	Technical defect.	Call DrägerService – only restricted operation is now possible.
!! Gas delivery failure	Technical defect.	Call DrägerService – only restricted operation is now possible.

Message	Cause	Remedy
!! High frequency	Patient breathes at a high spontaneous rate.	Check patient's condition, check ventilation pattern, correct alarm limit f_{spn} if necessary.
!! Int. battery charging inop	Technical defect.	Call DrägerService – only restricted operation is now possible.
!!! Int. battery discharged	The operating time for operation with the internal battery has expired and an external DC supply has not been connected.	The ventilator must immediately be reconnected to a mains supply, an on-board DC supply or a fully charged battery.
!! Int. battery in use	Oxylog 3000 draws its power from the internal battery due to the absence of an external DC supply.	Press »Alarm Reset« key to confirm alarm.
!! Key failed	Technical defect.	Call DrägerService – only limited operation is now possible.
!!! Leakage (not in NIV)	The measured expiratory tidal volume VT is approx. 40 % lower than the inspiratory value.	Repair leaks in patient system and possibly in tube. Use new flow measuring hoses.
	Faulty flow sensor.	Replace flow sensor.
	The ventilator may not function properly.	Call DrägerService.
!! Loss of data	Technical defect.	Call DrägerService – only restricted operation is now possible.
!! Loudspeaker inop	Technical defect.	Call DrägerService – only restricted operation is now possible.
!!! MV high	The upper alarm limit for the minute volume MV has been exceeded.	Check patient's condition, check ventilation pattern, adjust alarm limits if necessary.
	Faulty flow sensor.	Replace flow sensor.
	The ventilator may not function properly.	Call DrägerService.
!!! MV low	The minute volume MV has dropped below its lower alarm limit.	Check patient's condition, check ventilation pattern, adjust alarm limits if necessary.
	Leak in breathing system.	Ensure connections in breathing system are tight.
	Faulty flow sensor.	Replace flow sensor.
	The ventilator may not function properly.	Call DrägerService.
!! No int. battery ?	Internal battery not fitted.	Fit battery or confirm alarm.
! No int. battery ?	Internal battery not fitted.	Advisory message, is displayed continuously when confirmed.
! No int. battery charging	Internal battery faulty or wrong battery fitted. Internal battery cannot be charged.	Change internal battery.
	Battery charge outside temperature range.	Note applicable temperature range for charging the internal battery.
!!! Paw high	The alarm limit Pmax for the airway pressure has been reached. Patient "fights" the machine, coughing.	Check patient's condition, check ventilation pattern, adjust alarm limits if necessary.
	Ventilation hose kinked, stenosis.	Check hose system, breathing valve, tube.

Message	Cause	Remedy
!!! Paw low	No pressure difference >5 mbar between inspiration and expiration or set pressure level is not achieved. Leak in cuff.	Inflate cuff and check for leaks.
	Leakage or disconnection.	Check hose system for leaking connections. Ensure that the breathing valve has been fitted correctly.
!! Paw measurement inop	Fault in measurement hoses for flow measurement on patient side.	Ensure measurement hoses for flow measurement on patient side are connected correctly.
	Technical defect.	Call DrägerService – only restricted operation is now possible.
! Self test o.k.	The device has been switched on and the self-test completed successfully.	The message can be confirmed or it will be cancelled automatically with the next message.
! Settings not confirmed	Parameters have been changed on the screen but not confirmed.	Press the rotary knob to confirm the parameter changes.
!!! Supply pressure low	Supply pressure <2.7 bar.	Ensure that supply pressure exceeds 2.7 bar.

Messages in the information window

(Numerical examples)

Message	Cause	Explanation/Remedy
f = 12 per min or VT = 800 ml I : E = 1 : 1,5 Flow = 15 L/min	Change in T _{insp} , f or VT in ventilation mode SIMV.	
f = 12 per min or VT = 800 ml T _{insp} = 0,7 s Flow = 35 L/min	Change in I/E, f or VT in ventilation mode IPPV (CMV), IPPVAssist (CMVAssist)	
I : E = 1 : 1,5 T _{exp} = 2 s	Change in T _{insp} or f in ventilation mode BIPAP (PCV+).	
Confirm PEEP above 10 mbar ?	PEEP >10 mbar has been set but not confirmed.	The required setting of PEEP >10 mbar is only possible when confirmed via the central rotary knob.
Gas consumption = 10 L/min	Standard display in information window for the current gas consumption.	
(Battery capacity)	Standard display in information window for the current battery capacity.	
P _{insp} >=PEEP + 3 mbar !	Set PEEP+ 3 mbar >P _{insp} .	Set P _{insp} > PEEP+ 3 mbar.
PASB = 22 mbar	Change in Δ ASB or PEEP.	PASB is the absolute pressure resulting from PEEP + Δ ASB.



Care 58

 Disassemble reusable ventilation set 58

 Remove disposable hose set 60

 Cleaning and disinfecting 60

 Sterilising reusable hose sets 62

 Maintenance intervals 62

 Batteries 63

 Device disposal 63

Care

- Clean breathing valve, flow sensor, angled connector and ventilation hoses of the reusable hose set whenever they have been used.
- The disposable hose set must always be disposed of correctly after use.
- Clean ventilator and medical gas hoses if heavily soiled.

Disassemble reusable ventilation set

- 1 Disconnect ventilation hose from socket.
- 2 Disconnect flow measuring hoses from sockets.
- 3 Unscrew medical gas hose from Oxylog 3000.

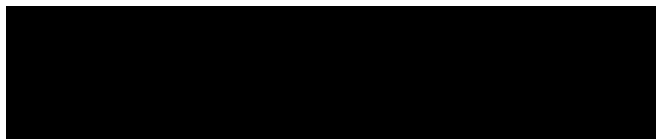
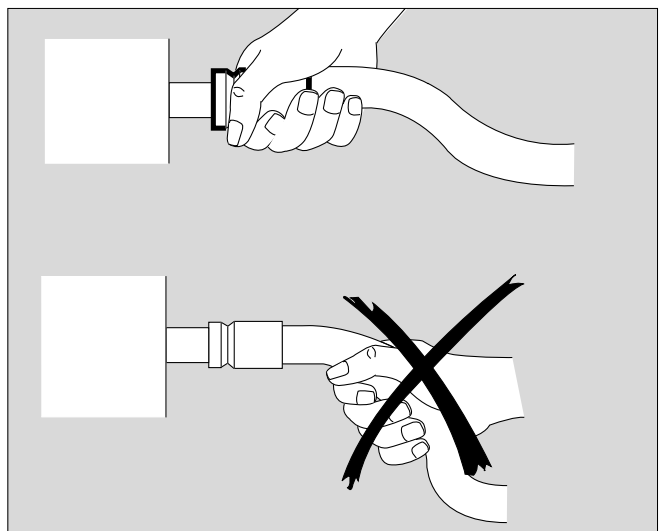
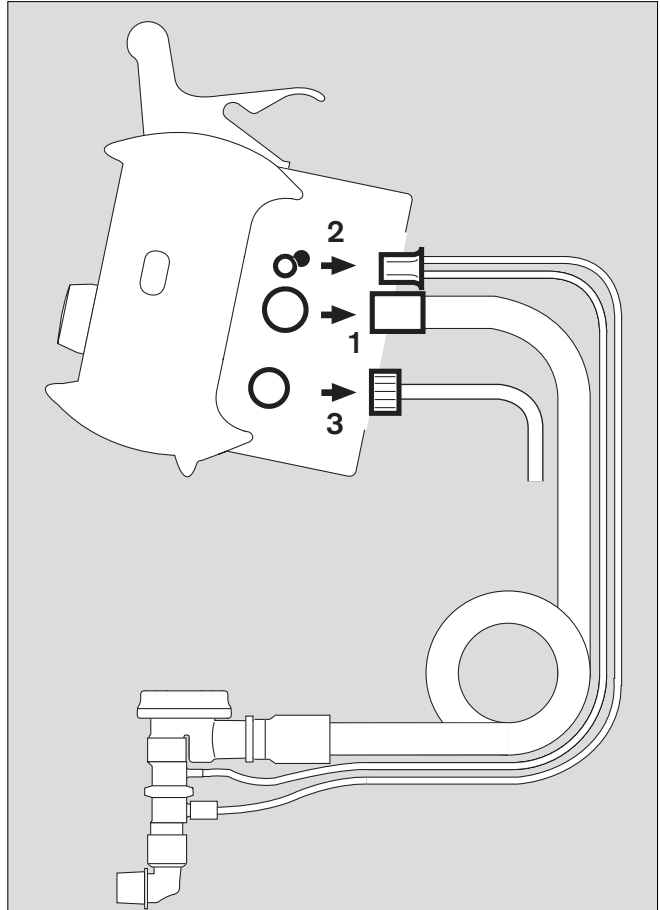



- 2 Carefully detach flow measuring hoses from flow sensor, pulling in the axial direction of the hose nozzles.
- 3 Detach angled connector from flow sensor.



- 4 Detach ventilation hose from breathing valve.

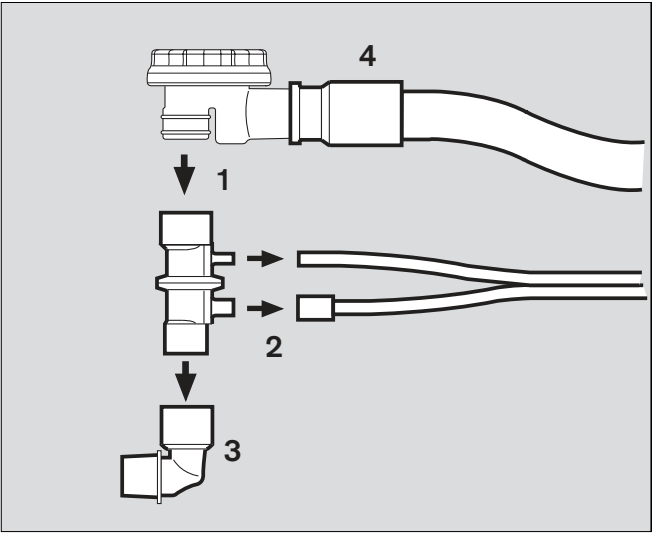

Breathing valve, disassembly

- 5 Turn cover about 90° anticlockwise = unlock and remove cover.
- 6 Remove silicone diaphragm.
- Do not disassemble breathing valve any further!

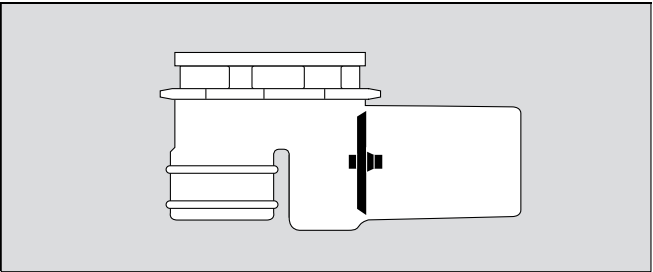
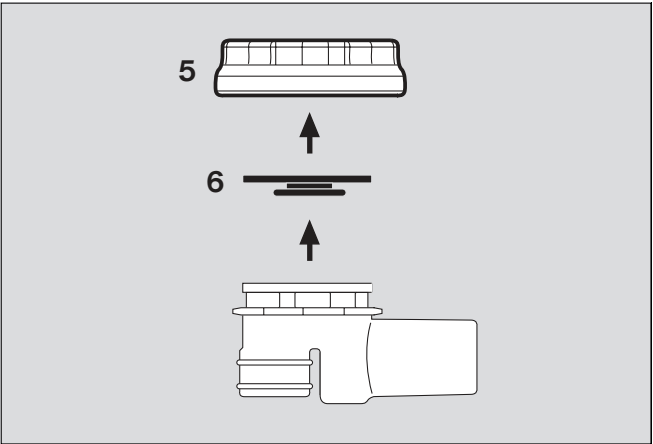
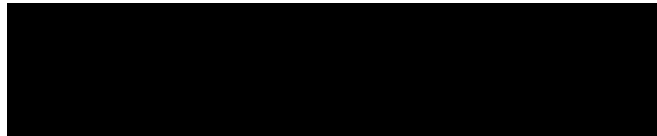

Remove disposable hose set

- 1 Disconnect flow measuring hoses.
- 2 Disconnect ventilation hose.
- Correctly dispose of the complete disposable hose set.

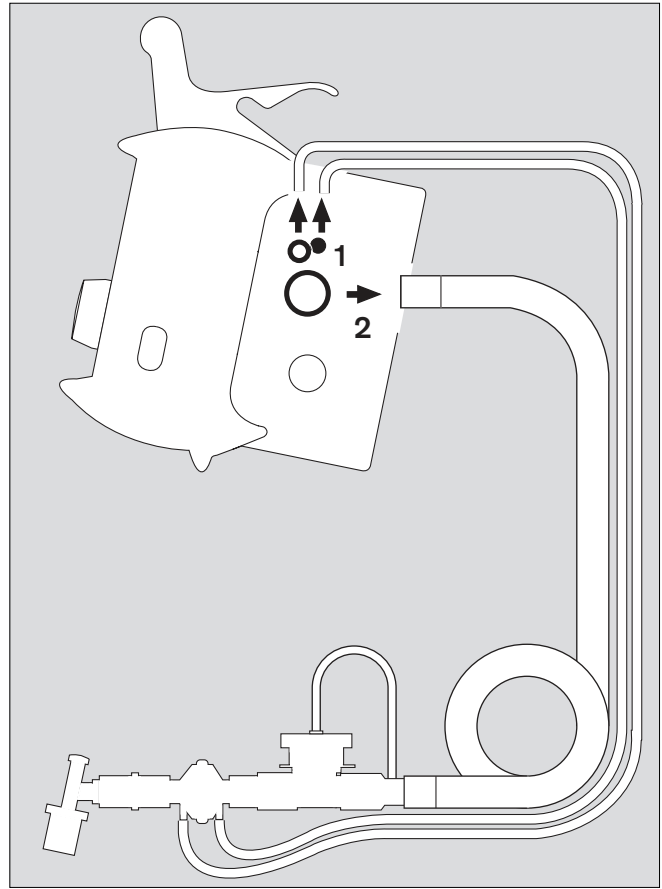

Cleaning and disinfecting

To ensure material compatibility, use disinfectants based on:

- aldehydes
- alcohols
- quaternary ammonia compounds.

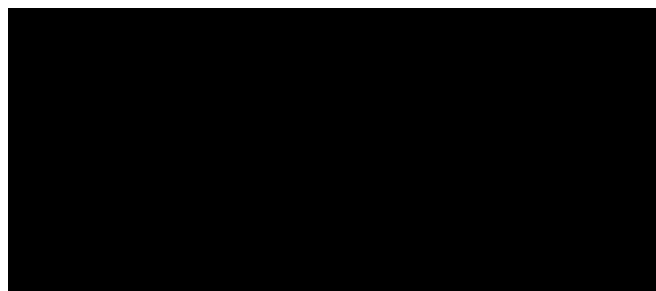

Users in the Federal Republic of Germany are recommended to use only disinfectants on the current DGHM list (DGHM: German Society for Hygiene and Microbiology).

The following disinfectants on the DGHM list are recommended:

- Dismozon pur
- Incidur
- Sekusept Powder
- Trichlorol

The DGHM list (published by: mhp-Verlag, Wiesbaden) also specifies the active ingredient in each disinfectant.

Disinfectants based on the active ingredients specified above are recommended for users in those countries in which the DGHM list is not available.

Disinfecting by wiping

Ventilator and medical gas hose:

- Follow the manufacturer's instructions. Remove heavy soiling with a disposable cloth first.



Bath disinfecting

Disassembled parts of the breathing valve, flow sensor, ventilation hose and flow measuring hoses:

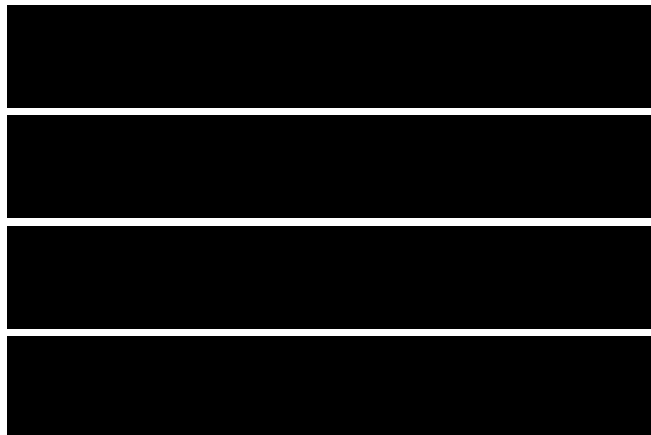

Sterilising reusable hose sets

Disassemble the breathing valve, flow sensor and angled connector. Dismantle the breathing valve.

The disassembled parts of the breathing valve, the flow sensor, the angled connector, the flow measuring hoses and the ventilation hose

- can be sterilized in hot steam at 134 °C in accordance with EN 285 (Sterilization – Steam sterilization – Large-scale sterilization) for at least 3 minutes.

Sterilization for up to 18 minutes is permissible, but will shorten the service life of the hose set.

After care

- Reassemble, page 16.
- Connect to power supply, page 19 and gas supply, page 22.
- Check readiness for operation, page 26.

Note service life of the hose set

The parts of the breathing valve, the flow sensor, the angled connector, the flow measuring hoses and the ventilation hose are resistant to the recommended disinfectants and to the temperatures occurring during sterilisation.

However, every disinfection and sterilisation cycle also means wear for the parts concerned.

For this reason, the parts must be examined for cracks and permanent deformation after the care procedure.

- Damaged or deformed parts must be replaced.

Maintenance intervals

- Must be carried out by trained service personnel
- Ventilator and parts must be disinfected and cleaned before starting any maintenance procedures, as well as before returning machine or parts for repairs!

Dust filter,	must be replaced after 2 years can be treated as household waste
internal battery	replace after 2 years or when the battery no longer remains charged for the specified operating time (battery operating time see page 90). Disposal as special waste.
Device inspection and maintenance	every 2 years

Batteries



Batteries are special waste:

- They must be disposed of in accordance with the local waste disposal regulations.

Device disposal

- at the end of its useful life.
- Oxylog 3000 must be disposed of correctly in consultation with the relevant waste disposal companies.
- The statutory regulations must be observed.



What's what	66
Front panel – standard version	66
Front panel with all options	67
Side view, right	68
Rear view	68
Reusable hose set	68
Disposable hose set	69

What's what

Front panel – standard version

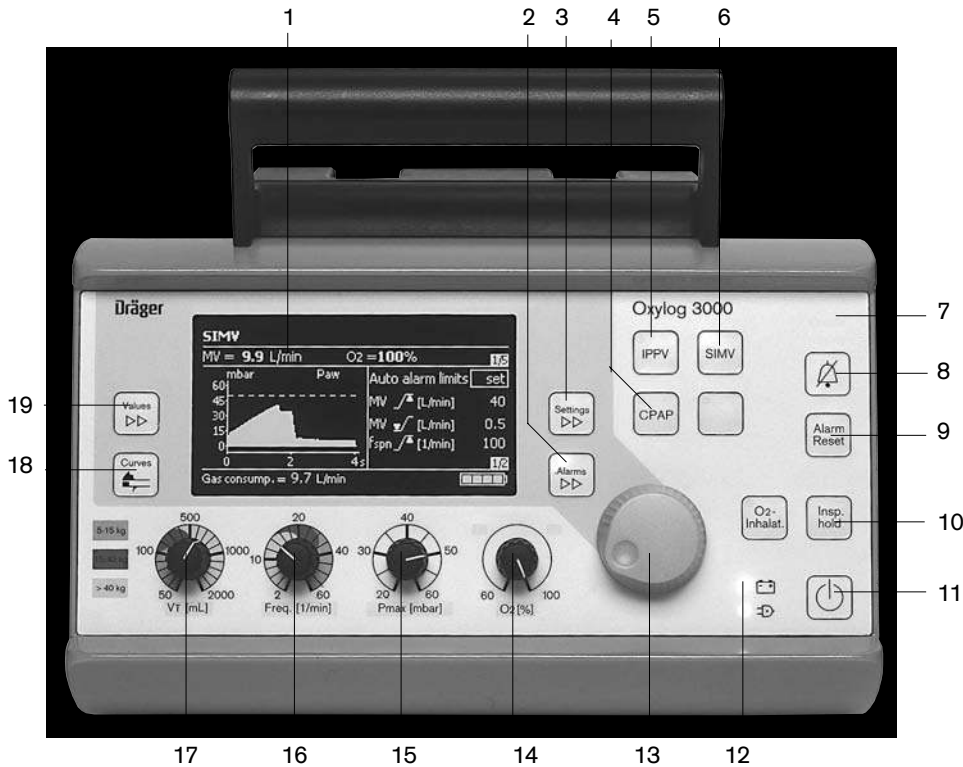

MF-154-2001

- 1 Screen with screen pages for the specific application
- 2 Key »Alarms $\triangleright \triangleright$ « for setting and displaying alarm limits
- 3 Key »Set. $\triangleright \triangleright$ « for setting other ventilation parameters on the screen
- 4 Key for ventilation mode **CPAP**
- 5 Key for ventilation modes **IPPV** (CMV), **IPPVAssist** (CMVAssist)
- 6 Key for ventilation mode **SIMV**
- 7 Red and yellow lamps as alarm indicators
- 8 Key » 🔇 « or muting the alarm tone for 2 minutes
- 9 Key »Alarm Reset« for acknowledging alarm messages
- 10 Key »Insp. hold« for manual inspiration
- 11 Key » ⏻ « for switching the ventilator ON/OFF
- 12 Display symbols for the power supply
 ⏻ Mains power supply
 🔋 Charge capacity of the internal battery
- 13 Central rotary knob for making selections / settings and for confirming these
- 14 Control knob for setting the O₂ concentration »O₂« to 60 % or 100 %, no other values
- 15 Control knob for setting the maximum inspiratory pressure »P_{max}«
- 16 Control knob for setting the ventilation frequency »Freq.«
- 17 Control knob for setting the tidal volume »VT«
- 18 Key »Curves 📊 « for zooming the curve display and changing over between displayed "Flow" and "Paw" curves
- 19 Key »Values $\triangleright \triangleright$ « for displaying measured values

Front panel with all options

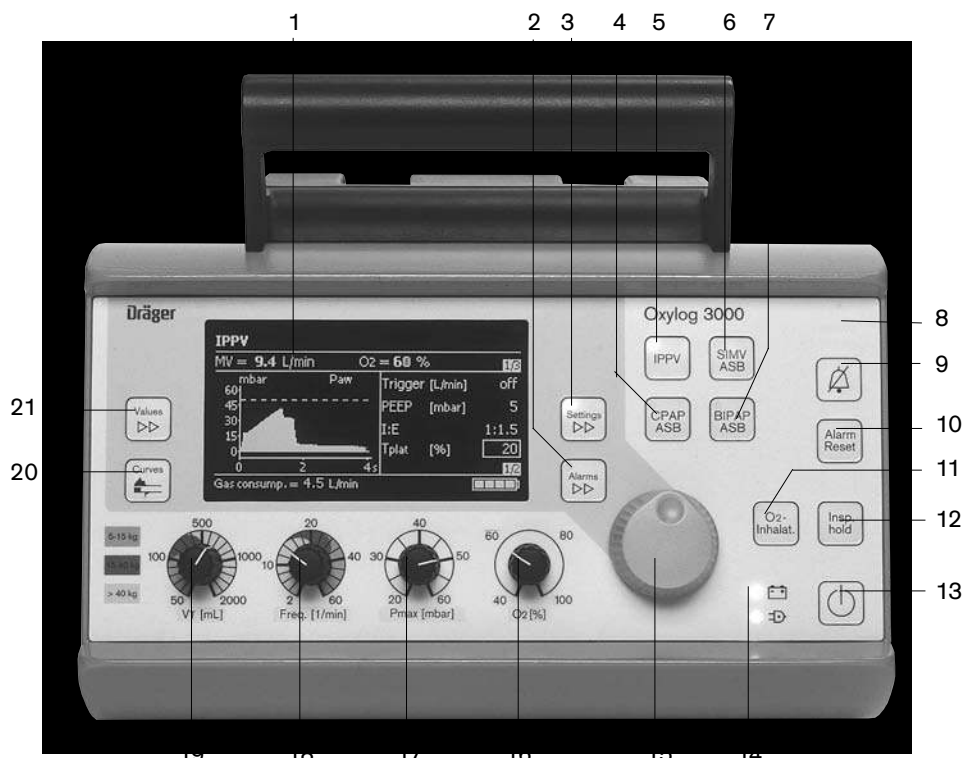

- | | |
|---|--|
| <p>1 Screen with screen pages for the specific application</p> <p>2 Key »Alarms $\triangleright\triangleright$ « for setting and displaying alarm limits</p> <p>3 Key »Set. $\triangleright\triangleright$ « for setting other ventilation parameters on the screen</p> <p>4 Key for ventilation modes CPAP, CPAP/ASB* (CPAP/PS)</p> <p>5 Key for ventilation modes IPPV (CMV), IPPVAssist (CMVAssist)</p> <p>6 Key for ventilation modes SIMV, SIMV/ASB* (SIMV/PS)</p> <p>7 Key for ventilation modes BIPAP (PCV+), BIPAP/ASB* (PCV+/PS)</p> <p>8 Red and yellow lamps as alarm indicators</p> <p>9 Key » bell « or muting the alarm tone for 2 minutes</p> <p>10 Key »Alarm Reset« for acknowledging alarm messages</p> <p>11 Key »O₂-Inhalat.« for changing over to O₂ inhalation or key »100 % O₂« for oxygenation</p> <p>12 Key »Insp. hold« for manual inspiration</p> <p>13 Key » power « for switching the ventilator ON/OFF</p> <p>14 Display symbols for the power supply
 power Mains power supply
 battery Charge capacity of the internal battery</p> | <p>15 Central rotary knob for making selections / settings and for confirming these</p> <p>16 Control knob for setting the O₂ concentration »O₂« to 40 % or 100 %*</p> <p>17 Control knob for setting the maximum inspiratory pressure »Pmax«</p> <p>18 Control knob for setting the ventilation frequency »Freq.«</p> <p>19 Control knob for setting the tidal volume »VT«</p> <p>20 Key »Curves \blacksquare « for zooming the curve display and changing over between displayed "Flow" and "Paw" curves</p> <p>21 Key »Values $\triangleright\triangleright$ « for displaying measured values</p> |
|---|--|

* CPAP/ASB, SIMV/ASB, BIPAP/ASB and O₂ % are optional functions

Side view, right

- 1 Screw for securing the battery compartment cover
- 2 Sockets for flow measuring hoses
- 3 Socket for ventilation hose or inhalation mask
- 4 Connector for medical gas hose
- 5 Socket for DC supply
- 6 Window for IrDA interface

■ Note Instructions for Use

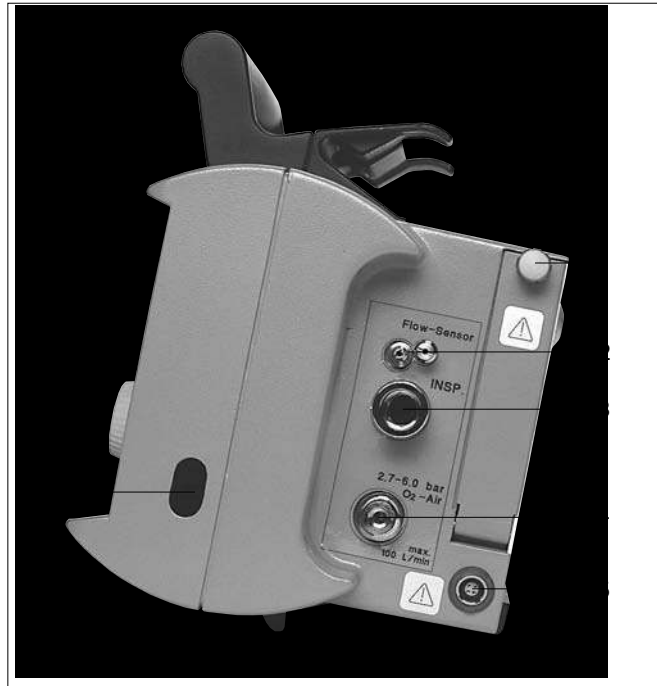

MT-1566-2/001

Rear view

- 7 Filter cartridge for ambient air
- 8 Rating plate



MT-1566-2/001

Reusable hose set

- 1 Breathing valve
- 2 Ventilation hose
- 3 Flow measuring hoses
- 4 Angled connector
- 5 Flow sensor

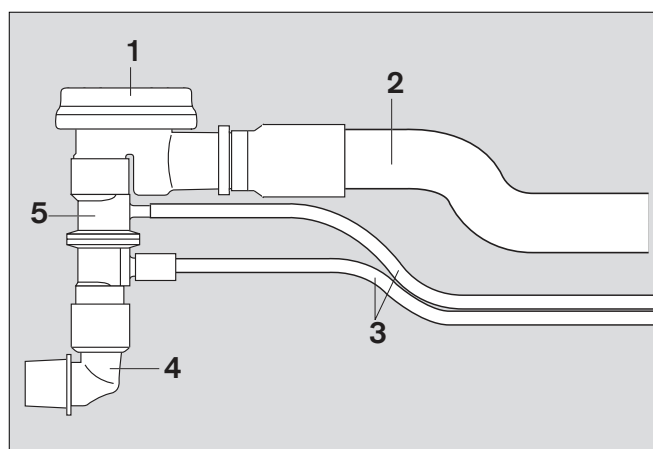

Disposable hose set

- 1 Breathing valve
- 2 Ventilation hose
- 3 Flow measuring hoses
- 4 Angled connector
- 5 Flow sensor

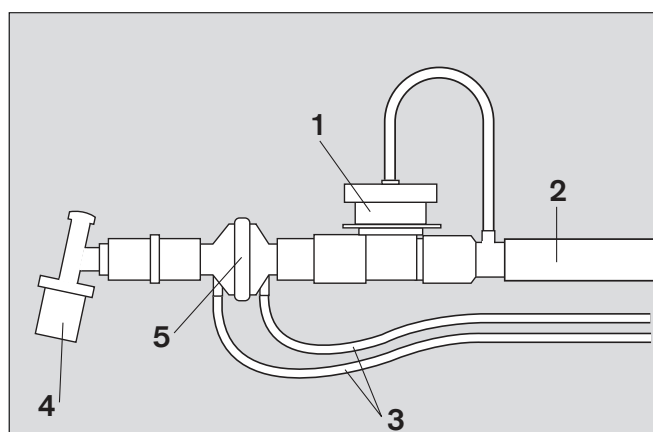



Carrier System 3000 (optional) 72

Onboard Equipment Holder (optional) 74

Carrier System 3000 (optional)

Intended use

Carrier System 3000 – transport unit for Oxylog 3000, with oxygen cylinder, pressure reducer and ventilation hose set for emergency care of patients, with optional choice of O₂ supply.

Preparing for use

- Connect the marked gas inlet of the Carrier System 3000 to a high-pressure oxygen supply with a pressure range between 3 and 6 bar.
- Slowly open the cylinder valve on the full O₂ cylinder.

Check correct functioning

- Check readiness for operation of Oxylog 3000 when connected to the high-pressure supply.
- Disconnect the high-pressure supply and check that Oxylog 3000 operates correctly.

Use

Changing cylinders:

- Check the level in the O₂ cylinder on the pressure gauge of the pressure reducer. If the O₂ cylinder is empty, release both tensioning levers securing the cylinder to the rear of the Carrier System. Unscrew and remove the pressure reducer and draw the O₂ cylinder sideways out of the Carrier System. Insert a full cylinder in the same direction, lifting up the tensioning straps at the same time. Move the tensioning levers down and secure the cylinder. The tensioning straps can be adjusted by pulling the straps in the tensioning lever.

Operation of the O₂ manifold:

- If O₂ cylinder and high-pressure supply are connected simultaneously, the manifold will preferably draw gas from the supply with the higher pressure. The supply source is selected automatically. This ensures that the cylinder cannot drain into the high-pressure supply when the cylinder valve is open.

Mounting on standard rails and tubes:

- The Carrier System can be mounted on various rail and tube profiles by means of the claw on the back of the Oxylog 3000. The device is hooked onto a standard rail by means of a rectangular recess provided for this purpose. Care must be taken to ensure that the claw is inserted completely in the rail. The device can also be mounted on tubes measuring up to 38 mm in diameter.



After use

- Disconnect the high-pressure supply and close the valve on the O₂ cylinder.

Technical data

Operating temperature	-20 °C to +70 °C
Storage temperature	-20 °C to +80 °C
Width x Height x Depth	450 x 400 x 240 mm
Weight with maximum equipment and 2.0 litre cylinder (glass-fibre-reinforced plastic material)	14.5 kg
Variable cylinder length	300 to 530 mm
Permissible cylinder weight	6.1 kg

Onboard Equipment Holder (optional)

Intended use

Onboard Equipment Holder – mounting unit for Oxylog 3000 which can be inserted, locked and subsequently removed by the user and which can be pivoted horizontally. The onboard equipment holder is designed for mounting on the roof or wall of a vehicle.

Preparing for use

- Secure the onboard equipment holder to the wall of the vehicle via the three mounting holes with M5 screw connections provided for this purpose.
- The hose for the high-pressure supply must also be secured to the wall.

Use

Insert Oxylog 3000 in the onboard equipment holder:

- Hook the cross-bar of the onboard equipment holder into the claw recess on Oxylog 3000. Swing the ventilator to the rear about the cross-bar until resistance is felt. Press firmly against the bottom edge of the ventilator control unit to engage it. A distinct click must be heard.

Remove Oxylog 3000 from the onboard equipment holder:

- Reach behind the Oxylog 3000 until the release lever of the onboard equipment holder can be felt and press it firmly forwards with the ball of the hand. The ventilator is released with a distinct click and swings downwards. It can then be removed from the onboard equipment holder by means of its handle.

Turn Oxylog 3000 in the onboard equipment holder:

- Hold the sides of the ventilator with both hands and turn it firmly about its vertical axis. The ventilator can be set to any position.

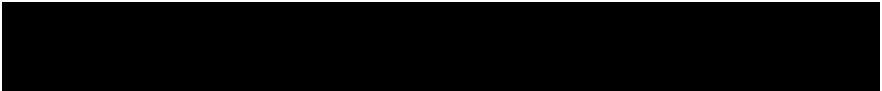

Service Mode	76
Customer Service Mode	76
Set startup settings	77
Select hose type	78
Set date and time	78
Set measured values display window	79
Enter activation code	79
Test buttons and potentiometer	79
Test loudspeaker, buzzer, LEDs and display	80
Display accu and supply data	80
Display actual technical error	80
Display error and info logbook	81
Display settings logbook	81
Display language text	81
Exit service mode	82

Service Mode

Customer Service Mode



In service mode, the ventilator performs function tests, outputs status information and permits configuration of parameter settings.

Displays in service mode appear in English and cannot be changed to any other language.

001	Set startup settings	Configure start-up settings, restore manufacturer's default settings
002	Select hose type	Determine which ventilation hose set is used (disposable or reusable)
003	Set date and time (Greenwich Mean Time GMT)	Set date and time
004	Set measured values display window	Configure the layout of measured values in the measured values window; restore manufacturer's default settings
005	Enter activation code	Enter the activation code for options
006	Test buttons and potentiometer	Check correct functioning of push-buttons and controls
007	Test loudspeaker, buzzer, LEDs and display	Check correct functioning of loudspeaker, buzzer, LEDs and screen
008	Display accu and supply data	Show battery data and condition of the supply voltage
009	Display actual technical errors	Display any active technical errors
010	Display error and info logbook	Calibration logbook and technical errors in chronological order
011	Display settings logbook	Logbook of operating phases and ventilator settings
012	Display language text	Display screen texts in two freely selected languages

Ventilation is not possible in service mode.

To enter service mode

- 1,2 Turn controls »VT« and »Freq.« to right-hand stop.
 - 3 Switch on the device = briefly press key »« and simultaneously press and hold
 - 4 »Curves  « key and
 - 5 »Values  « key until the main »Customer Service Mode« menu appears.
- Set the number of the required test in the main menu with the central rotary knob.
 - Activate test = press rotary knob.

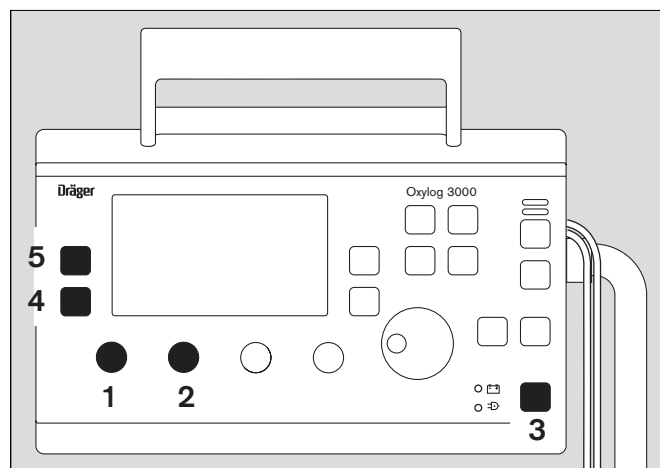

Settings in service mode

Select the required function with the cursor (asterisk).

- Select parameter = turn rotary knob.
- Activate parameter = press rotary knob.
- Set value = turn rotary knob.
- Confirm value = press rotary knob.

```
Customer Service Mode
Testnumber :      1
Set startup settings

Switch OFF to quit servicemode
Ver. 01.00 (22.10.2001)
```

Quit test:

- Select line »EXIT« = press rotary knob and confirm.

The set values are saved and remain effective whenever ventilation is started after switching on.

```
Set startup settings
Mode      = IPPU
Trigger   = 0 lpm
PEEP      = 5 mbar
I:E       = 1.0:1.5
Tinsp     = 2.0 s
Tplat     = 0%
dASB      = 0 mbar
Ramp      = STANDARD
Pinsp     = 20 mbar
O2-Flow   = 10 lpm

Set factory default
*EXIT
```

Set startup settings

The default settings for the parameters are displayed on the screen when the ventilator is switched on and can be adjusted.

Display (example):

```
Set startup settings
Mode      = IPPU
Trigger   = 0 lpm
PEEP      = 5 mbar
I:E       = 1.0:1.5
Tinsp     = 2.0 s
Tplat     = 0%
dASB      = 0 mbar
Ramp      = STANDARD
Pinsp     = 20 mbar
O2-Flow   = 10 lpm

*Set factory default
EXIT
```

Switch over to the second page:

- Select line»Page«, confirm and turn rotary knob.

Display (example):

```
Set startup settings
NIV       = OFF
TApn      = 500ms
VTApn     = 500ml
fApn      = 12bPm
MUspn-high = 40.00 lpm
MUspn-low  = 0.5 lpm
fspn-high  = 100 bpm

Loudness  = 3/4
Brightness-min = 1/4
Brightness-max = 3/4

Set factory default
EXIT
```

To restore the manufacturer's defaults:

- Select and confirm line »Set factory default«.

Range of settings:

Parameter	Range
T _{insp}	0.2 to 10.0 s
I:E	3.0/1.0 to 1.0/4.0
PEEP	0 to 20 mbar
Δ ASB	0 to 35 mbar
P _{insp}	0 to 55 mbar
Ramp	SLOW, STANDARD, FAST
T _{Apnoea}	0 to 30 s
T _{plat}	0 to 50 %
Trigger	0 to 15 L/min
MV-high	2.0 to 41 lpm
MV-low	0.5 to 40 lpm
Frequ.-high	10 to 100 bpm
Sound	1/4 to 4/4
Brightness	1/4 to 4/4
NIV	ON, OFF
O ₂ -Flow	0 to 15 L/min

Select hose type

The type of ventilation hose (reusable or disposable hose set) can be configured.

The connectors on the measuring line must also be changed when using a different type of hose set.

```
Select hose type
Hose type = reusable
*EXIT
```

11537170

Set date and time

The date and time can be set.

- Set the current date and time with the positions Year, Month, Day, Hour and Minute.
- Date and time can be reset with »Set«.

```
Set date and time (GMT)
30.10.2001 11:12:41
Year
Month
Day
Hour
Minute
Set
*EXIT
```

10237170

Set measured values display window

The arrangement of measured value pairs on the individual pages of the measured values display window can be varied. Each measured value can be freely selected in any position and is only displayed at that position.

- Start configuration on page 1/5 and continue through to 5/5.

```

Set measured values display
window
-----
|  MU           02           |  1/5
-----
|  f            VTe         |  2/5
-----
|  PEEP        MEAN        |  3/5
-----
|  PEAK        Pplat       |  4/5
-----
|  MVspn       fspn        |  5/5
-----

Set factory default
*EXIT
    
```

1163770

Enter activation code

The activation codes for options can be entered. The activated options are then displayed.

```

Enter activation code

Device-ID: 5354168
Activated: 02 blender
           ASB
           BIPAP
           INHALATION

New code : 0000000000
Set

*EXIT
    
```

1163770

Test buttons and potentiometer

The operating elements on the front panel are displayed schematically on the screen.

Display = screen
B = buttons

Set the controls accordingly for the test:

- »VT« to 500 mL
- »Freq.« to 20 1/min
- »Pmax« to 40 mbar
- »O2« to 40 % (or 60 % if optional "O2 blending" is not installed)

These settings are displayed on the screen.

To test the buttons:

- Briefly press the corresponding button. The associated letter on the screen changes from "B" to "X". If the button has an LED, it will be illuminated by the device. In the case of buttons without LED, the yellow warning lamp lights up on the device.



The function of the rotary knob is not included in the test.

```

Test buttons and potentiometer
Press (B)uttons, adjust potis
=====
##### B B B
#
B # Display # B B B B
#
B ##### B B B
UT Freq. Pmax O2
2000 60 30 40
[m] [bpm] [mbar] [%]
=====
*EXIT
    
```

0943770

Test loudspeaker, buzzer, LEDs and display

Tests the loudspeaker, buzzer, all LEDs and the display.

Select the required test

- Start the test. Each function is tested by the device.

To test the screen display (Test display):

- Turn the rotary knob; various test cards are displayed. The selected test remains active until the rotary knob is pressed again.

```

Test loudspeaker, buzzer, LEDs
and display

Test loudspeaker: !!! WARNING
Test loudspeaker: !!! CAUTION
Test loudspeaker: ! ADVISORY
Loudness = 3/4

Test buzzer
Test LEDs

Test display
Brightness min = 1/4
Brightness max = 3/4

*EXIT
    
```

0953770

Display accu and supply data

The parameters of the replaceable battery and the status of the external power supply are displayed.

Display (example):

```

Display accu and supply data

Charger          : U00.86
Ext. supply      : ok
Accu state       : charge
Accu type        : ME20ZAF
Accu manufact    : EONE MOLI
Accu serialnr.   : 40
Accu chemistry   : LION
Accu date        : 24.03.2001
Accu cycle       : 5
Accu designcap   : 5400 mAh
Accu fullcap     : 5302 mAh
Accu actualcap   : 74 %

*EXIT                               Page 1/2
    
```

0953770

Switch over to the second page:

- Select line »Page«, confirm and turn rotary knob.

Display (example):

```

Display accu and supply data

Accu voltage     : 12.4 V
Accu current     : 1477 mA
Charg. voltage   : 12.6 V
Charg. current   : 1500 mA

EXIT                               *Page 2/2
    
```

11337170

Display actual technical error

Momentarily active technical errors are displayed with the error number and a brief description.

Display (example):

```

Display actual technical error

H 04-0027
POTI: FREQ unplugged
H 04-0026
POTI: VT unplugged
H 04-0028
POTI: PMAX unplugged
H 04-0029
POTI: O2 unplugged

*EXIT
    
```

0953770

Display error and info logbook

Any technical errors and/or special occurrences, such as activation of a software option, completion of the device check and device calibration, are listed in chronological order.

Display (example):

Change over to the next page:

- Select line »Page«, confirm and turn rotary knob.

```

Display error and info logbook
I 00-0000 31.10.2001 07:35:51
INFO: Device test successful
I 00-0000 31.10.2001 07:28:36
INFO: Valve 01 calibrated
I 00-0000 31.10.2001 07:27:58
INFO: Valve 02 calibrated
I 00-0000 31.10.2001 07:27:26
INFO: Valve 03 calibrated
*EXIT Page 001/009
  
```

1035170

Display settings logbook

The operating phases with ventilator settings and time are listed in chronological order.

Change over to the next page:

- Select line »Page«, confirm and turn rotary knob.

```

Display settings logbook
Power-ON : 31.10.2001 07:44:09
Mode = IPPV
Trig. = OFF UT = 540 ml
PEEP = 5 mbar Freq. = 20 bpm
I:E = 1:1.5 O2 = 40 %
Tplat = 0 % Pmax = 30 mbar

MUspn-Alarms = 0.5 .. 40 lpm
fspn-Alarm = 100 bpm
Brightness = 1/4 .. 3/4
Loudness = 3/4
EXIT *Page 003/078
  
```

11237170

Display language text

Alarm messages and advisory messages are displayed by the ventilator in the selected display languages – one text per page.

To change to another page:

- Select line »Page«, confirm and turn rotary knob.

To change to another language:

- Select line »Language 1« or »Language 2«, confirm and turn rotary knob.

Texts can be displayed in the following languages:

- German
- English
- US-English
- French
- Spanish
- Swedish
- Portuguese
- Italian
- Dutch

```

Display language text

Language 1: English
Language 2: Deutsch

!!! Paw high

!!! Atemwegsdruck hoch

EXIT *Page 004/030
  
```

1035170

Exit service mode

- Press key »⏻« for 3 seconds; its yellow lamp flashes.

To switch ventilation on:

- Briefly press key »⏻«.

To switch off:

- Press rotary knob.



















Abbreviations	84
Symbols	85

Abbreviations

Abbreviation	Explanation	Abbreviation	Explanation
ASB (PS)	A ssisted S pontaneous B reathing Pressure-assisted spontaneous breathing	Paw	Airway pressure
BIPAP (PCV+)	B iphasic P ositive A irway P ressure Spontaneous breathing with continuous positive airway pressure and two different pressure levels	PCV+	P ressure C ontrolled V entilation plus
BIPAP/ASB (PCV+/PS)	B iphasic P ositive A irway P ressure A ssisted S pontaneous B reathing Pressure-controlled ventilation in combination with spontaneous breathing throughout the breathing cycle and with variable pressure support at CPAP level	PEEP	Positive end expiratory pressure
BTPS	B ody T emperatur, P ressure, S aturated Measured values referred to the conditions of the patient's lung, body temperature 37 °C, ambient pressure, water-vapour-saturated gas	Pinsp	Set value of the upper pressure level in BIPAP
C	Compliance	Pmax	Maximum airway pressure
CMV	C ontrolled M andatory V entilation	Pmean	Mean airway pressure
CPAP	C ontinuous P ositive A irway P ressure Spontaneous breathing with continuous positive pressure	Ppeak	Maximum airway pressure
CPAP/ASB (CPSP/PS)	C ontinuous P ositive A irway P ressure A ssisted S pontaneous B reathing Spontaneous breathing at an elevated pressure level	Pplat	End inspiratory airway pressure
EN 794-3	European standard for medical ventilators, Part 3 "Emergency and transport ventilators"	PS	P ressure S upport
Δ ASB	Set value for pressure support ASB – Δ ASB over PEEP	R	Resistance
f	Ventilation frequency	Ramp	Set value for the rise in pressure over time for pressure assistance with ASB
f _{Apnoea}	Frequency of apnoea ventilation	SIMV	S ynchronized I ntermittent M andatory V entilation
Freq.	Ventilation frequency	SIMV/ASB (SIMV/PS)	S ynchronized I ntermittent M andatory V entilation A ssisted S pontaneous B reathing Ventilation can be supplemented with ASB
f _{spn}	Spontaneous breathing rate	T _{Apnoea}	Apnoea alarm time
IPPV (CMV)	I ntermittent P ositive P ressure V entilation	Te	Expiration time
IPPV _{Assist} (CMV _{Assist})	A ssisted I ntermittent P ositive P ressure V entilation	T _{insp}	Set inspiration time
I:E	Ratio inspiration time : expiration time	T _{plat}	Plateau time
MV	Minute volume	VT _{Apnoea}	Tidal volume of apnoea ventilation
MV _{spn}	Proportion of the minute volume which is accounted for by spontaneous breathing	VT	Set tidal volume
NIV	Non-invasive ventilation – mask ventilation	V _{Te}	Exp. Tidal volume
O ₂	Set value for the inspiratory O ₂ concentration	V _{Ti}	Insp. Tidal volume
O ₂ -inhalat.	O ₂ inhalation	100 % O ₂	100 % O ₂ flow

Symbols

Symbol	Explanation
	Inspiration is started and held manually
	Display screen window "Settings"
	Display screen window "Alarms"
	Display screen window "Measured values"
	Changeover between flow / pressure curve
	Suppress acoustic alarm for 2 minutes
	Acknowledge alarms
	Standby/Operation switch
	Lower and upper alarm limits
	Upper alarm limit only
	Lower alarm limit only
!	Advisory message
!!	Caution message
!!!	Warning
	Strictly follow the Instructions for Use!
	Protection class B (body)
	Protection class BF (body floating)
	DC supply
	AC supply
	Battery charge (example: half full)



Technical Data 88

Technical Data

Ambient conditions

During operation

Temperature	-20 to 50 °C ¹⁾
Atmospheric pressure	570 to 1200 hPa
Rel. humidity	5 to 95 %

During storage

Ventilator without replaceable battery, with reusable ventilation hose set

Temperature	-40 to 75 °C
Atmospheric pressure	570 to 1200 hPa
Rel. humidity	5 to 95 %

Disposable ventilation hose set

Temperature	-20 to 70 °C
Atmospheric pressure	570 to 1200 hPa
Rel. humidity	30 to 50 %

Replaceable battery

Temperature	-20 to 35 °C
Atmospheric pressure	570 to 1200 hPa
Rel. humidity	5 to 95 %

Settings

Ventilation modes

IPPV (CMV)/IPPVAssist (CMVAssist), SIMV, SIMV/ASB (SIMV/PS), BIPAP (PCV+), BIPAP/ASB (PCV+/PS), CPAP, CPAP/ASB (CPAP/PS)

Ventilation frequency Freq.

2 to 60 1/min ± 1 1/min (SIMV, BIPAP)
5 to 60 1/min ± 1 1/min (IPPV, IPPVAssist)
12 to 60 1/min ± 1 1/min for apnoea ventilation

Ventilation time ratio I:E (IPPV, IPPVAssist)

1:4 to 3:1

Inspiration time T_{insp} (SIMV, SIMV/ASB, BIPAP, BIPAP/ASB)

0.2 to 10 s

Tidal volume V_T

0.05 to 2.0 L, BTPS²⁾

Accuracy

±15 % of set value or ±25 mL, whichever is greater.

Inspiratory pressure P_{insp}

PEEP+3 mbar to 55 mbar³⁾

O₂ concentration

40 to 100 Vol.%⁴⁾

Accuracy

±10 Vol.%

The setting depends on the inspiratory flow⁵⁾

Positive end expiratory pressure PEEP

0 to 20 mbar ± 2 mbar, no negative pressure

Trigger sensitivity (flow trigger)

3 to 15 L/min

1) when used with disposable hose set. -10 to 50 °C

2) BTPS

Body Temperature, Pressure, Saturated.

Measured values referred to the conditions of the patient's lungs, body temperature 37 °C, ambient pressure, water-vapour-saturated gas.

3) 1 mbar = 100 Pa

4) with optional O₂ blending

5) see O₂ concentration, page 42

Pressure support Δ ASB	0 to 35 mbar (relative to PEEP) \pm 2 mbar
Rise time for pressure support	slow, standard, fast
Performance data	
Control principle	time-cycled, volume-constant, pressure-controlled
Max. inspiratory flow	100 L/min ¹⁾
Device compliance	
with 1.5 m ventilation hose	\leq 1 mL/mbar
with 3 m ventilation hose	\leq 2 mL/mbar
Inspiration resistance	\leq 4 mbar at 60 L/min
Expiration resistance	\leq 4 mbar at 60 L/min
Dead space incl. flow sensor	approx. 28 mL (reusable hose set) approx. 32.5 mL (disposable hose set)
Supplementary functions	
Demand valve	Opens the breathing system upon failure of the gas supply, permits spontaneous breathing with ambient air
Relief valve	Opens the breathing system at approx. 80 mbar
Max. permissible differential pressure for flow measurement	\pm 4 mbar
Resistance of flow sensor	3 mbar at 100 L/min (reusable hose set) 2.5 mbar at 100 L/min (disposable hose set)
Patient connection	22 mm ISO conical connector
Measured value display	
Airway pressure measurement	
Range	0 to 99 mbar
Resolution	1 mbar
Accuracy	\pm 2 mbar
Max. airway pressure	Ppeak
Pos. end expiratory pressure	PEEP
Mean airway pressure	Pmean
Plateau pressure	Pplat
Flow measurement	
Minute volume MV	
Range	0 to 99 L/min, BTPS
Resolution	0.1 L/min
Accuracy	\pm 15 % of measured value, but at least \pm 1 L/min
Tidal volume V_Te	
Range	0 to 5000 mL, BTPS
Resolution	1 mL
Accuracy	\pm 15 % of measured value

1) At service pressures >3.5 bar
The maximum inspiratory flow is reduced to 80 L/min at service pressures <3.5 bar

Frequency measurement

Range	0 to 99 /min
Resolution	1 /min
Accuracy	±1 /min

Curve display

Airway pressure Paw (t)	-10 to 100 mbar
Flow (t)	-120 to 120 L/min

Monitoring

Expiratory minute volume MV

Alarm, upper alarm limit	when the upper alarm limit has been exceeded
Range of settings	41 to 2 L/min
Alarm, lower alarm limit	when the level drops below the lower alarm limit
Range of settings	0.5 to 40 L/min

Airway pressure Paw

Alarm, upper alarm limit	when value "Pmax" is exceeded
Range of settings	20 to 60 mbar
Alarm, lower alarm limit	When pressure difference between inspiratory and expiratory sides is less than 5 mbar or if the set pressure level is not attained.

Apnoea alarm time T_{Apnoea}

Alarm	when respiratory activity is no longer detected
Range of settings	15 to 60 s, can be set in 1 s increments

Operating data

Power supply

Power supply	
Input voltage Oxylog 3000	19 V ±0.5 V DC
With DC/DC converter	12 V / 24V / 28 V DC

Current consumption

With battery charge	max. 3.8 A, typically 2.1 A
Operating time with fully charged internal battery without mains supply for "typical" ventilation	Approx. 4 hours
Operating time with fully charged nickel metal hydride battery, without mains supply for "typical" ventilation	Approx. 3 hours
Battery charge	The device switches over to floating operation when the battery is fully charged.
Battery types	Nickel metal hydride battery Lithium ion battery

Charging times	The specified charging times apply when recharging the battery fully after it has been exhausted.
Nickel Metal Hybrid battery	Approx. 4 hours
Lithium ion battery	Approx. 5 hours
Permissible ambient temperature during charging	0 °C to 35 °C
Indication of battery capacity	in 25 % increments
Accuracy of the capacity indication	The indicated capacity is determined by the battery itself. The accuracy depends on the type and manufacturer and may deteriorate with frequent partial discharge and during operation in extreme temperatures. The internal battery is only reconditioned after being discharged completely and recharged at room temperature 25 °C. The criteria for the warnings "!!! Int. battery discharged" and "!! Charge int. battery" are therefore based on measurement of the battery voltage. The capacity indicated at this moment may differ from the actual capacity of the internal battery.
Battery storage time	The internal battery must always be removed from Oxylog 3000 for storage and recharged completely after 12 months at the latest (e.g. in the external Oxylog 3000 battery charging station)
AC/DC power pack	
Temperature range	-20 °C to 50 °C
Protection class to EN 60601	Class I
Input	100 to 240 V~/ 50 to 60 Hz / 1.5 A
Output	19 V ±0.5 V / 2.1 A, max. 3.8 A
Internal fuse	3.15 A slow-blow
DC/DC converter	
Temperature range	-20 °C to 50 °C
Input	10 to 32 V DC / 8 A
Output	19 V ±0.5 V / 2.1 A, max. 3.8 A
Internal fuse	10 A slow-blow
Gas supply	From a pipeline system or from a medical gas cylinder
O2 service pressure	3 bar -10 % to 6 bar at 100 L/min
Supply gas	Medical oxygen or medical air
O2 inlet connection	either: DIN to DIN 13252, or NIST ¹⁾ to EN 739, or DISS ²⁾ to CGA V5-1989, or N-F ³⁾ 590-116/1987.
	The gas must be dry and free of oil and dust.

1) NIST = Non Interchangeable Screw Thread Connection
2) DISS = Diameter Index Safety Systems
3) N-F = French standard

Gas cylinders and pressure reducers	must comply with national regulations and be officially approved.
Pressure reducer	must have a vent valve on the output side to limit the delivery pressure to approx. 10 bar in the event of a fault.
Gas consumption for internal control	0.1 to 0.5 L/min
Accuracy of gas consumption indication	±0.5 L/min
Noise pressure	<45 dB (A) for typical ventilation at a distance of 1 m
Dimensions (W x H x D)	
Basic unit	285 x 184 x 175 mm (without handle)
AC/DC power pack	158 x 60 x 117 mm
DC/DC converter	162 x 42 x 69 mm
Weight	
Basic unit with internal battery	Approx. 4.9 kg
AC/DC power pack	Approx. 0.8 kg
DC/DC converter	Approx. 0.4 kg
Electromagnetic compatibility EMC	tested to EN 60601-1-2 and EN 794-3 (36.101) 10 V/m
Airworthiness (vibration)	In accordance with RTCA DO-160D
Mechanical strength	In accordance with MIL STD 810 E
Classification according to Directive 93/42/EEC Appendix IX	Class IIb
UMDNS-Code Universal Medical Device Nomenclature System	18 – 098
Interface	IrDA Infrared RS232 interface
Protection class, ventilation hose sets (disposable or reusable)	Type BF  (body floating)

Materials used

Housing, Oxylog 3000	Impact-proof acrylonitrile butadiene styrene (ABS)
Housing, AC/DC power pack	Impact-proof acrylonitrile butadiene styrene (ABS)
Housing, DC/DC converter	Impact-proof acrylonitrile butadiene styrene (ABS)
Touch sensitive keypad on ventilator	Polyester film
Reusable ventilation hose set	
Ventilation hose, flow measuring hoses	Silicone rubber
Flow sensor housing, breathing valve	Polysulphone (PSU)
Vane in flow sensor	Stainless steel
Diaphragms in breathing valve	Silicone rubber
Disposable ventilation hose set	
Ventilation hose	Polyethylene (PE)
Non-return valve	Synthetic resin
Breathing valve	Polyethylene (PE)
Flow sensor housing	Polymethyl methacrylate (PMMA)
Film in flow sensor	Polyester
Adapter	Silicone rubber
Patient connection	Polypropylene (PP)
Display	
Technology	Electro-luminescence (EL)
Pixels	240 x 128
Visible area	108 x 56 mm



Description	96
Ventilation modes	96
Volume-controlled ventilation	96
IPPV (CMV)	96
IPPVAssist (CMVAssist)	96
SIMV	97
ASB (PS)	98
BIPAP (PCV+)	99
Functional description	101

Description

Ventilation modes

Volume-controlled ventilation

IPPV (CMV)

Volume-constant mandatory ventilation stroke

The ventilation pattern is specified by the settings for tidal volume V_T , frequency Freq., ventilation time ratio I:E and PEEP.

At the end of the flow phase, the expiration valve remains closed until the end of the inspiration time T_{insp} . This phase, the inspiratory pause, can be identified as the plateau P_{plat} in the curve $P_{aw}(t)$.

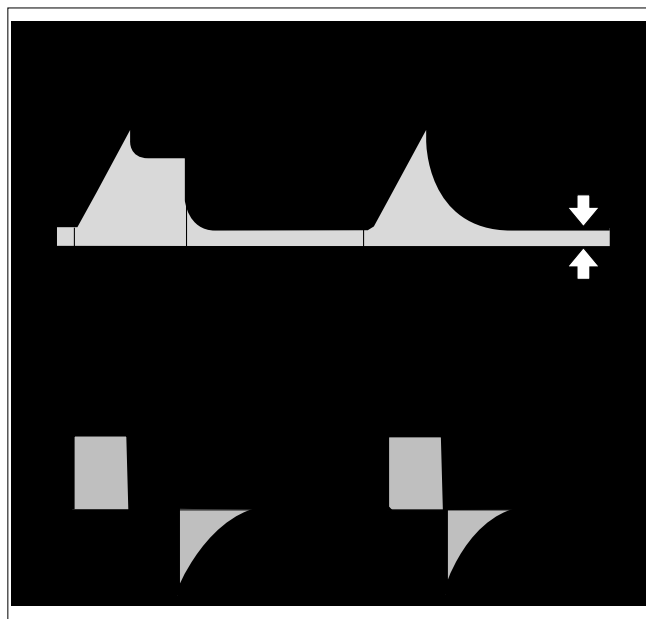

IPPVAssist (CMVAssist)

Assisted ventilation with continuous positive airway pressure.

The mandatory ventilation stroke begins when the patient reaches an inspiratory flow corresponding at least to the flow trigger set.

The current ventilation frequency may be greater than the set frequency for the same trigger.

SIMV

Synchronised Intermittent Mandatory Ventilation

Combination of mandatory ventilation and spontaneous breathing

SIMV enables the patient to breathe spontaneously in regular prescribed cycles, with the mechanical mandatory ventilation strokes providing a minimum ventilation during the remaining cycles.

The minimum ventilation is controlled by the two set values tidal volume V_T and frequency Freq. and is determined from the product of $V_T \times \text{Freq.}$

The ventilation pattern results from the ventilation parameters tidal volume V_T , frequency Freq. and inspiration time $T_{\text{insp.}}$

To prevent the mandatory ventilation stroke being applied during spontaneous expiration, the Flowtrigger of the ventilator ensures that the ventilation stroke is triggered in synchrony with the patient's spontaneous inspiratory effort within a "trigger window".

The trigger window is 5 seconds long. If the expiration times are less than 5 seconds, the trigger window covers the entire expiration time less a minimum expiration time of 500 ms.

Since the synchronisation of the mandatory ventilation stroke reduces the effective SIMV time, which would result in an undesirable increase in effective frequency, Oxylog 3000 prolongs the subsequent spontaneous breathing time by the missing time difference ΔT – thus preventing an increase in SIMV frequency. The frequency parameter Freq. remains constant. This parameter, in combination with the tidal volume V_T , sets the minimum ventilation.

During the spontaneous breathing phases, the patient can be assisted with pressure by ASB pressure support.

In the course of progressively weaning the patient from artificial ventilation, the ventilation frequency f is further reduced while the spontaneous breathing time is increased, so that the required total minute volume is supplied more and more by spontaneous breathing.

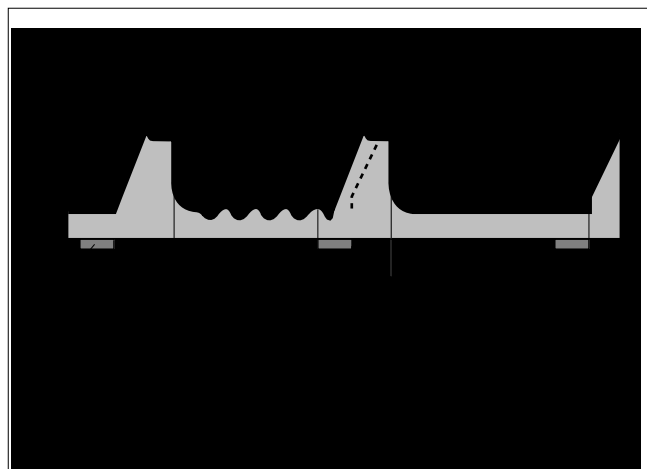

ASB (PS)

Assisted Spontaneous Breathing (Pressure Support)

Pressure support for insufficient spontaneous breathing.

The function of the machine in assisting insufficient spontaneous breathing is similar to that of the anaesthetist who manually assists and monitors the patient's spontaneous breathing by feeling the breathing bag.

The machine takes over part of the inhalation function, with the patient maintaining control of spontaneous breathing.

The CPAP system supplies the spontaneously breathing patient with the breathing gas, even if the inspiration effort is weak.

The pressure support of the ASB system is started: when the spontaneous inspiration flow reaches the set value of the Flowtrigger, or at the latest when the spontaneous inspired volume exceeds 25 mL.

The machine then produces an increase in pressure up to the preselected ASB pressure Δ ASB above PEEP, which is adjustable to the breathing requirement of the patient.

The time for this pressure increase («Ramp») is adjustable:

- In case of rapid increase in pressure Oxylog 3000 supports the insufficient spontaneous breathing of the patient with a high peak flow.
- In case of slow increase in pressure Oxylog 3000 begins gently with regular inspiratory flow. The patient has to take over more breathing effort, and tone of breathing muscles improves.

With the patient adjusted pressure increase and the pressure Δ PASB above PEEP, the patient's own breathing activity defines the required inspiration flow.

ASB is terminated:

- when the inspiration flow returns to zero during phase I, i.e. when the patient exhales or fights the ventilator or
- when the inspiration flow in phase II falls below 25 % of the inspiration flow previously supplied (and thus Δ PASB above PEEP is reached)
- or
- at the latest after 4 seconds if the two other criteria have not come into operation.

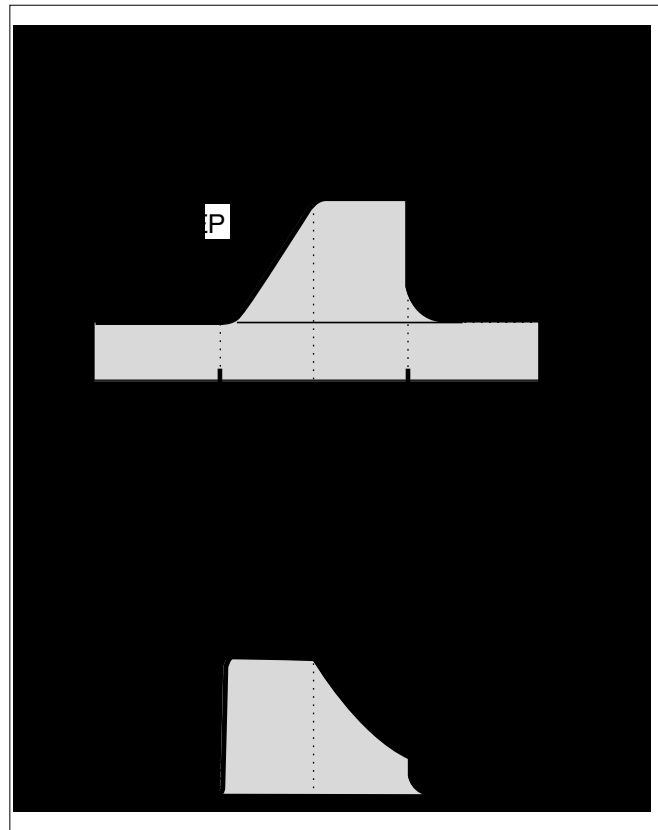

BIPAP (PCV+)

Biphasic Positive Airway Pressure
(Pressure Controlled Ventilation plus)

The BIPAP ventilation mode is a pressure-controlled / time-cycled ventilation mode in which the patient can always breathe spontaneously. BIPAP is therefore often described as a time-cycled alternation between two CPAP levels.

The time-cycled change of pressure gives controlled ventilation, which corresponds to pressure-controlled ventilation PCV. However, the constant option of spontaneous breathing allows the transition from controlled ventilation to independent spontaneous breathing to take place smoothly via the weaning phase, without requiring any change of the ventilation mode. To adapt easily to the patient's spontaneous breathing pattern, the changeover from expiratory pressure level to inspiratory pressure level, and also the changeover from inspiratory pressure level to expiratory pressure level, are synchronised with the patient's spontaneous breathing.

The frequency of the changeover is kept constant, even when synchronisation occurs via a trigger window with fixed time constant.

This smooth adaptation to the patient's spontaneous breathing requires less sedation, so that the patient returns to spontaneous breathing more rapidly.

As in all pressure-controlled ventilation modes, the patient is not prescribed a fixed tidal volume V_T . The tidal volume results principally from the pressure difference between the settings for PEEP and P_{insp} and also lung compliance.

The display of the expiratory measured tidal volume V_{Te} must be used to set the required difference between the two pressure levels. Any increase in this difference will cause an increased BIPAP ventilation stroke.

Changes in lung compliance and airways, as well as active 'fighting' by the patient can lead to changes in tidal volume. This is a desired effect in this ventilation mode.

With the knowledge that the tidal volume, and therefore the minute volume, are not constant, the alarm limits for minute volume must be adjusted with care.

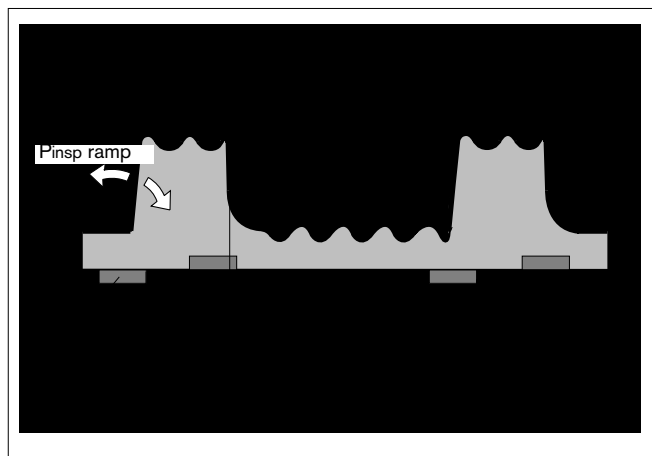

03187171

Using BIPAP

As with SIMV, the time pattern is set using the basic setting parameters of frequency Freq. and inspiration time T_{insp} . The lower pressure level is set with the PEEP parameter, while the upper level is set with P_{insp} .

When switching over from IPPV to BIPAP mode, note that the inspiration time T_{insp} is set instead of the ventilation time ratio I:E.

When switching over from SIMV to BIPAP mode – while retaining the time pattern – only the P_{insp} setting needs to be changed.

The steepness of the increase from the lower pressure level to the upper pressure level is controlled by the »Ramp« setting.

During the lower pressure level phase, spontaneous breathing can be assisted by ASB.

The steepness of the pressure increase to ASB pressure ΔP_{ASB} above PEEP is also controlled by the »Ramp« setting.

The transition from controlled ventilation via the weaning phase to fully spontaneous breathing is achieved by a gradual reduction of inspiratory pressure P_{insp} and/or frequency Freq.

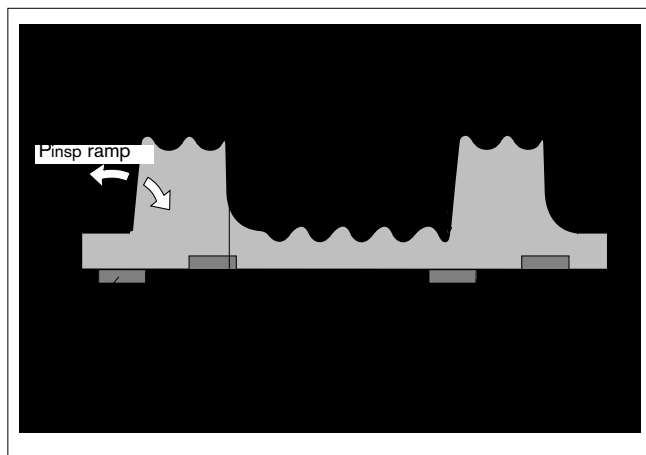

081587171

Functional description

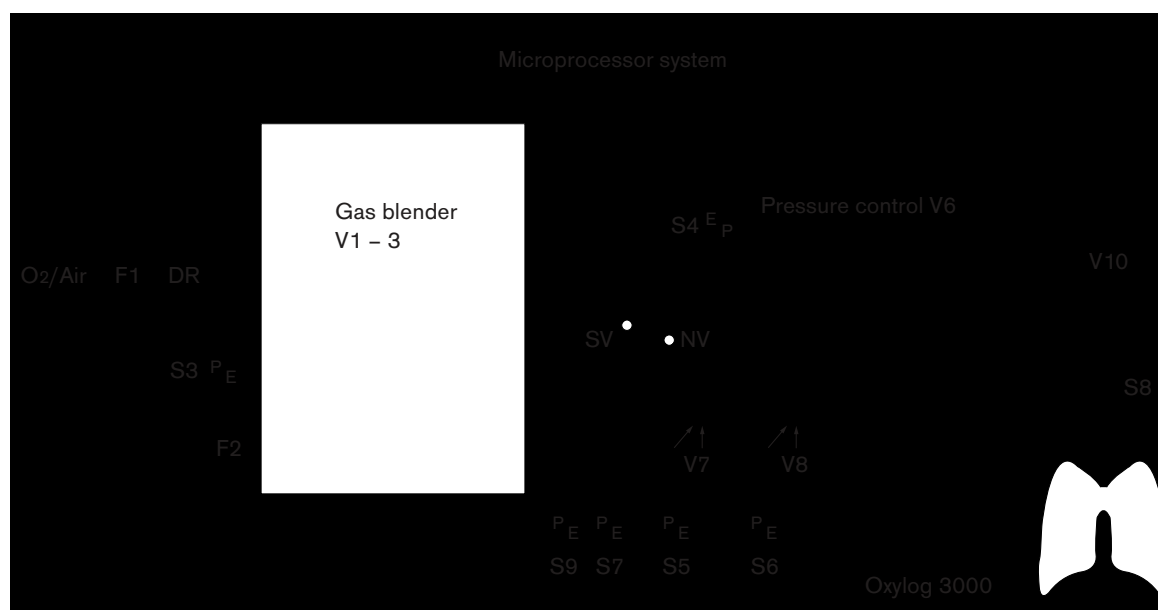

The variable pneumatic actuators in the Oxylog 3000 are controlled by the microprocessor system via digitized electrical test signals.

Gas supply

The supply gas O₂ (or compressed medical air in exceptional cases) is purified by filter F1 and adjusted to a constant pressure by pressure regulator DR. Ambient air is taken in via filter F2 as required. The supply pressure is monitored by pressure sensor S3.

Inspiration

Gas blender V1-3 delivers the variable inspiration flow as a mixture of supply gas O₂ and ambient air in accordance with the ventilation mode and required O₂ concentration. The tidal volume is applied regardless of ambient pressure (absolute pressure sensors S7 and S9) under patient conditions BTPS* for volume-controlled breathing; the applied tidal volume corresponds with that set for BTPS, taking into account the ambient pressure. In this way, Oxylog 3000 meters and measures roughly 10 % less volume in operation with a test lung (dry gas at room temperature).

Expiration

During volume-controlled inspiration, pressure control V6 closes the inspiratory canal and control the PEEP pressure during expiration or reduces the pressure in the inspiration hose to control the ASB, P_{insp} or P_{max} pressure when the

target values are reached. Breathing valve V10 on the patient side, which is indirectly controlled by V6, seals off against atmospheric air during inspiration and adjusts the required patient pressure during expiration by controlling the pressure in the inspiration hose. The measured value of the airway pressure sensor S5 on the patient side serves as setpoint for pressure regulation.

Safety

In the event of a fault, gas blender V1-3 closes and pressure control V6 opens to the atmosphere. The pneumatic demand valve NV (spontaneous breathing) opens in the presence of a negative pressure. The pneumatic relief valve SV (set to approx. 80 mbar) opens in the presence of an excess pressure.

Monitoring

The flow measured on the patient side by S8 is transmitted to the internal electronic pressure difference sensor S6 as a differential pressure signal. This signal is displayed on the screen as the flow curve. The measured monitoring values tidal volume, minute volume and frequency are derived from the measured expiratory flow. The inspiratory flow signal is used for detection of the flow trigger. System leakages can be identified from the balance of inspiratory and expiratory tidal volumes (e.g. leakage alarm, NIV).

Airway pressure measurement on the patient side supplies the P_{aw} values for the airway pressure curve on the screen via S5, as well as for the derived measured values PEEP, P_{peak}, P_{plat}, P_{mean}. The plausibility of this airway pressure measurement on the patient side is monitored by a redundant second internal airway pressure measurement in the ventilator via S4 in the inspiratory duct.

* BTPS
Body Temperature, Pressure, Saturated.
Measured values referred to the patient lung,
body temperature 37 °C, ambient pressure,
water-vapour-saturated gas.

Order List

Part name	Part No.	Part name	Part No.
Workstation		ZV*-O ₂ /Air Air connecting hose with angled connector for central supply and DIN connection	
Oxylog 3000	2M 86300	Length 1.5 m	M 29 285
Basic unit		Length 3.0 m	M 29 245
Oxylog 3000	2M 86955	Length 5.0 m	M 29 265
Accessories required for operation		ZV-O ₂ /Air Air connecting hose with angled connector for central supply and NIST connection	
Power supply:		Length 1.5 m	M 34 410
AC/DC power pack 100-240 V/50-60 Hz	2M 86 730	Length 3.0 m	M 34 411
Available power cables:		Length 5.0 m	M 34 412
Germany and Europe	18 24 481	Special accessories	
Denmark	18 44 342	Wall bracket (for portable system)	2M 86 725
United Kingdom	18 44 369	Onboard equipment holder	2M 86 900
Australia	18 44 350	Wall adapter	2M 86 934
Switzerland	18 44 377	Set of "Adult" catheter connectors	84 03 685
USA	18 41 793	Corrugated hose	84 02 041
DC/DC converter	2M 86 731	Connector for O ₂ inhalation	M 20 101
Nickel metal hydride battery	2M 86 732	Oxylog 3000 battery charging station	2M 86 729
or			
Lithium ion battery	2M 86 733		
Reusable ventilation hose set, comprising:		Options	
Ventilation hose with measuring leads, 1.5 m	84 12 068	BIPAP (PCV+)	ME 05 056
Ventilation hose with measuring leads, 3 m	84 12 913	ASB (PS)	ME 05 055
Breathing valve	84 12 001	O ₂ blending	ME 05 054
Flow sensor	84 12 034	100 % O ₂	ME 05 053
Angled connector	84 12 235	O ₂ inhalation	ME 05 052
Disposable ventilation hose set (set of 5):	2M 86 841		
Test lung	84 03 201		
Connecting hoses:			
O ₂ /Air hose			
for use on the pressure reducer			
Screw thread M 12 x 1 and 15 x 1			
Length 1.5 m	M 17 616		
Length 3.0 m	2M 86 687		

* Central piped gas supply

Part name	Part No.
Oxylog 3000 emergency rescue units	
Portable system, complete	2M 86 970
For supplying the Oxylog 3000 from a piped	
medical gas supply or cylinder via an	
O ₂ manifold, comprising:	
Oxylog 3000	
Ventilation hose with measuring leads	
Breathing valve	
Flow sensor	
Angled connector	
O ₂ cylinder, 2.5 L	
O ₂ pressure reducer	
O ₂ manifold	
Equipment bags	

Index

100 % O ₂	48	Flow curves main page	13
Abbreviations	84	Front panel – standard version	66
Accessories	6	Front panel with all options	67
Advisory	46	Gas failure	46
Air Mix	42	Gas supply	22
Alarms screen window	13	Heart-lung resuscitation	35
Ambient conditions	88	HME (Heat Moisture Exchanger)	17
Angled connector	16	Hyperbaric chambers	6
Apnoea ventilation	39	Information window	14
Areas of explosion hazard	6	Informations	51
Areas of use	8	Inspiration hold	48
ASB	98	Intended medical use	8
Bacterial filter	17	Internal supply with rechargeable battery	19
Bath disinfecting	61	IPPV, IPPVAssist	33
Battery capacity	20	Liability	6
Battery operation	20	Magnetic resonance imaging	6
Battery type	52	Maintenance	6
BIPAP, BIPAP / ASB	37	Maintenance intervals	62
Breathing valve	59	Manual inspiration	48
BTPS	84	Manual ventilation equipment	6
Calibration	50	Measured value display	89
Care	58	Measured values	47
Carrier System 3000 (optional)	72	MIL STD 810 E	92
Caution	45	Mobile phones	6
Charging the battery	20	Monitoring	90
Checking readiness for operation	26	NIV Non-invasive ventilation	41
Cleaning	60	No Air Mix	42
CMV	33	O ₂ inhalation	8
CMVAssist	33	Onboard Equipment Holder	74
Configuration	51	Operating concept	10
CPAP, CPAP / ASB	38	Operating data	90
Curves	47	Operation	32
Customer Service Mode	76	Optional "O ₂ blending"	42
DC/DC converter	21	PCV+	99
Description	96	Performance data	89
Disinfecting	60	Piped medical gas system	24
Disinfecting by wiping	61	Pneumatic operation time	23
Display accu	80	Pollutants	6
Display actual technical error	80	Power supply	19
Display language text	81	Power supply unit	21
Display logbook	81	Precautions	6
Disposable hose set	18, 69	Pressure curves main page	13
Event of an Alarm	45, 54	Pressure limitation	44
Exit service mode	82		
External power supply	21		
Fault – cause – remedy	54		

Primary care	10
PS	98
Replacing the battery	19
Reusable hose set	16, 69
Routine and additional functions	11
RTCA DO-160D	92
Screen Operating Controls	11
Screen windows	12
Secondary transfers	10
Service Mode	75
Set data and time	78
Set gas supply	52
Set language	52
Set startup settings	77
Setting alarm limits	44
Settings	88
Settings screen window	12
Shutdown	50
SIMV	97
SIMV, SIMV / ASB	36
Special functions	48
Suppress alarm tones	46
Symbols	85
Technical Data	88
Test buttons	79
Test buzzer	80
Test display	80
Test LEDs	80
Test loudspeaker	80
Test lung	26
Test potentiometer	79
Test supply data	80
Trigger (IPPVAssist)	34
Values screen window	12
Ventilation modes	8
Wall bracket	102
Warning	45
What's what	66

These Instructions for Use apply only to

Oxylog 3000

with Serial No.:

If no Serial No. has been filled in by Dräger these Instructions for Use are provided for general information only and are not intended for use with any specific machine or device.



Directive 93/42/EEC
concerning Medical Devices

Dräger Medical AG & Co. KGaA

Germany

🏠 Moislinger Allee 53 – 55

D- 23542 Lübeck

☎ +49 451 8 82- 0

📠 26 80 70

FAX +49 451 8 82- 20 80

🌐 <http://www.draeger.com>

90 37 171 - GA 5503.403 en

© Dräger Medical AG & Co. KGaA

2nd edition – April 2002

Subject to alteration

This "Instructions for Use" manual is published for public use and is only meant for your information.
We do not guarantee the accuracy of these instructions with respect to your specific device type or status.
Only the "Instructions for Use" manual delivered together with a device is officially published for the use of that specific device.